



Cambridge International Examinations
Cambridge Ordinary Level

CHEMISTRY

5070/12

Paper 1 Multiple Choice

May/June 2018

1 hour

Additional Materials: Multiple Choice Answer Sheet
Soft clean eraser
Soft pencil (type B or HB is recommended)



READ THESE INSTRUCTIONS FIRST

Write in soft pencil.

Do not use staples, paper clips, glue or correction fluid.

Write your name, Centre number and candidate number on the Answer Sheet in the spaces provided unless this has been done for you.

DO NOT WRITE IN ANY BARCODES.

There are **forty** questions on this paper. Answer **all** questions. For each question there are four possible answers **A, B, C** and **D**.

Choose the **one** you consider correct and record your choice in **soft pencil** on the separate Answer Sheet.

Read the instructions on the Answer Sheet very carefully.

Each correct answer will score one mark. A mark will not be deducted for a wrong answer.

Any rough working should be done in this booklet.

A copy of the Periodic Table is printed on page 16.

Electronic calculators may be used.

This document consists of **16** printed pages.

- 1 A student wants to show that the rate of the reaction between calcium carbonate and dilute hydrochloric acid doubles for every 10 °C rise in temperature.

The method the student uses is to measure the volume of carbon dioxide released.

The student has a Bunsen burner and a gas syringe.

What other essential apparatus must the student use?

- A** balance, burette, pipette, measuring cylinder
B balance, measuring cylinder, clock, thermometer
C burette, pipette, clock, thermometer
D pipette, measuring cylinder, clock, thermometer
- 2 Which mixture can be separated into its components by adding water, stirring and filtering?
- A** calcium carbonate and sodium chloride
B magnesium and iron
C sodium chloride and copper(II) sulfate
D sulfuric acid and hydrochloric acid
- 3 Which row gives the correct tests to identify both ammonia and sulfur dioxide?

	test to identify ammonia	test to identify sulfur dioxide
A	damp blue litmus paper	acidified potassium manganate(VII)
B	damp blue litmus paper	damp red litmus paper
C	damp red litmus paper	acidified potassium manganate(VII)
D	damp red litmus paper	damp blue litmus paper

- 4 Two gases, ammonia and hydrogen chloride, at an equal pressure, are allowed to enter the apparatus shown.

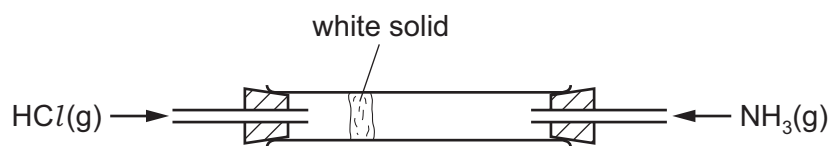

After a time, a white solid forms on the inside of the tube.

Which statements explain why a white solid forms in the position shown?

- 1 Ammonia and hydrogen chloride react to form solid ammonium chloride.
- 2 Ammonia diffuses faster than hydrogen chloride.
- 3 Ammonia has a lower relative molecular mass than hydrogen chloride.

- A** 1, 2 and 3 **B** 1 and 2 only **C** 1 only **D** 2 and 3 only

- 5 The atomic number of cerium, Ce, is 58. A Ce^{4+} ion has 140 nucleons in its nucleus.

How many protons, neutrons, and electrons are there in one Ce^{4+} ion?

	protons	neutrons	electrons
A	58	82	54
B	58	82	62
C	82	58	54
D	82	58	62

- 6 The diagrams show the arrangement of particles in three **solids**: X, Y and Z. The three solids are krypton, potassium and sodium chloride.

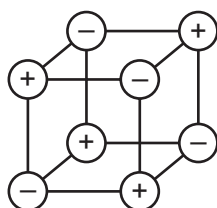

X

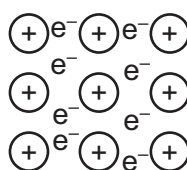

Y

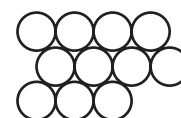

Z

Which row correctly identifies X, Y and Z?

	X	Y	Z
A	krypton	potassium	sodium chloride
B	krypton	sodium chloride	potassium
C	sodium chloride	krypton	potassium
D	sodium chloride	potassium	krypton

7 Which statement about solid calcium chloride is correct?

- A It conducts electricity.
- B It has a low melting point.
- C It has an ionic lattice structure.
- D It is insoluble in water.

8 Ethane, C_2H_6 , and ammonia, NH_3 , are covalent compounds.

The dot-and-cross diagrams of these compounds are shown.

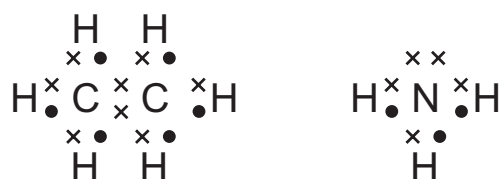

Which statements are correct?

- 1 A molecule of ethane contains twice as many hydrogen atoms as a molecule of ammonia.
- 2 An unreacted nitrogen atom has five outer electrons.
- 3 In a molecule of ethane, the bond between the carbon atoms is formed by sharing two electrons, one from each carbon atom.

A 1, 2 and 3 B 1 and 2 only C 1 and 3 only D 2 and 3 only

9 Which statement about the structure or bonding of metals is correct?

- A A metal lattice consists of atoms in a 'sea of electrons'.
- B Electrons in a metal move randomly through the lattice.
- C Metals are malleable because the particles present are mobile.
- D The ions in a metal move when positive and negative electrodes are attached.

10 When 1 volume of gas **R** reacts with exactly 5 volumes of oxygen, it forms carbon dioxide and water only.

What is **R**?

- A butane, C_4H_{10}
- B ethane, C_2H_6
- C methane, CH_4
- D propane, C_3H_8

11 The relative molecular mass of a compound is 166.

What is a possible molecular formula of this compound?

- A $C_4H_3O_2$ B $C_6H_4O_4$ C $C_6H_8O_2$ D $C_8H_6O_4$

12 A mass of 63 g of potassium manganate(VII), $KMnO_4$, is needed for the complete oxidation of 23 g of ethanol, C_2H_5OH , under acidic conditions.

How many moles of ethanol can be completely oxidised by one mole of potassium manganate(VII) under these conditions?

- A 0.37 B 0.80 C 1.00 D 1.25

13 The diagrams show an electrolysis experiment using inert electrodes.

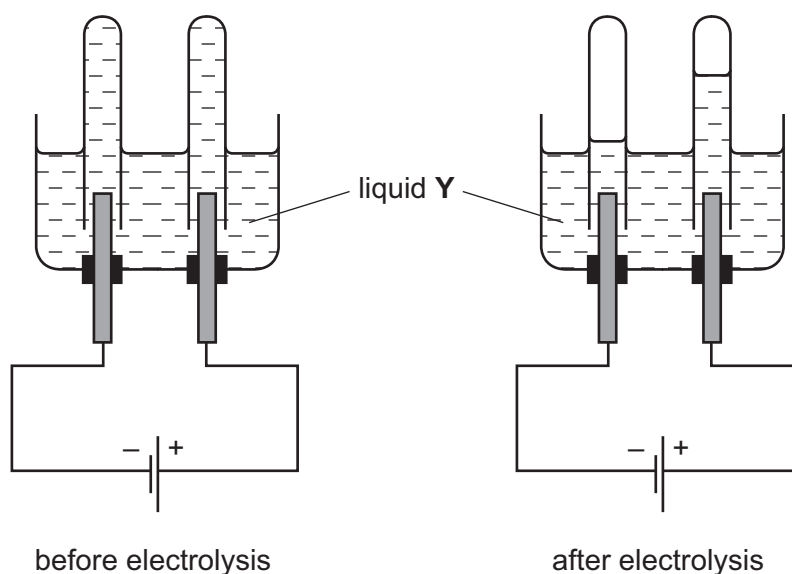

What could liquid Y be?

- A aqueous copper(II) sulfate
 B concentrated aqueous sodium chloride
 C dilute sulfuric acid
 D ethanol

14 Magnesium can be produced by the electrolysis of molten magnesium chloride, $MgCl_2$.

What are the products formed at the anode and at the cathode during the electrolysis of molten magnesium chloride?

	anode	cathode
A	chlorine	hydrogen
B	chlorine	magnesium
C	magnesium	chlorine
D	oxygen	hydrogen

15 The diagram shows apparatus that can be used to extract aluminium from its ore.

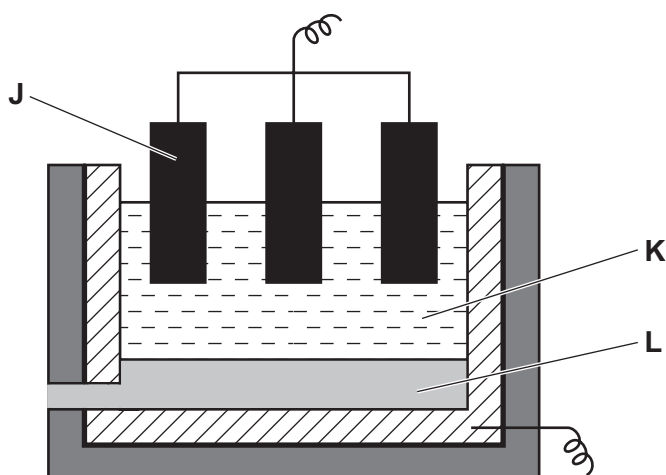

What are J, K and L?

	J	K	L
A	negative electrode	aluminium oxide + cryolite	aluminium
B	negative electrode	cryolite	aluminium oxide
C	positive electrode	aluminium oxide	cryolite
D	positive electrode	aluminium oxide + cryolite	aluminium

16 A reaction is exothermic.

Which diagram shows the correct energy profile diagram for the reaction and the correct enthalpy change?

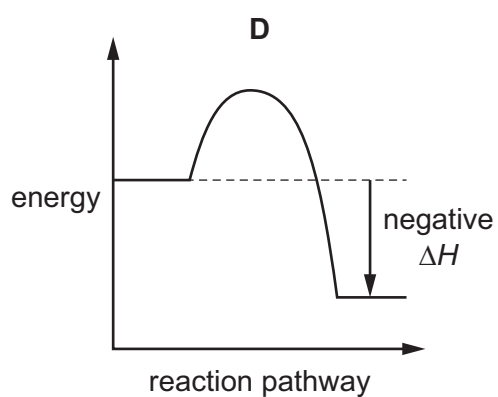
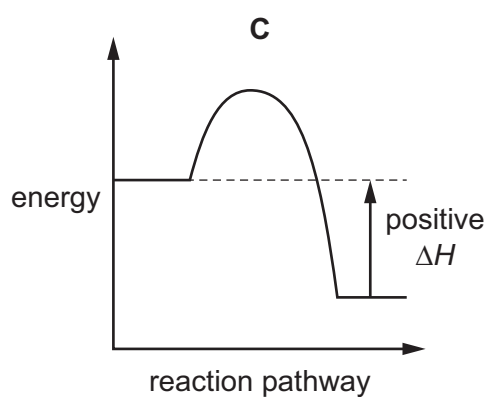
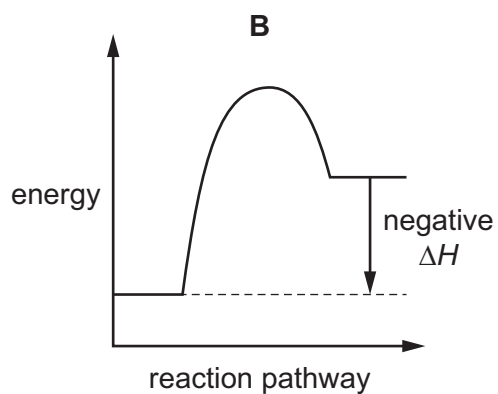
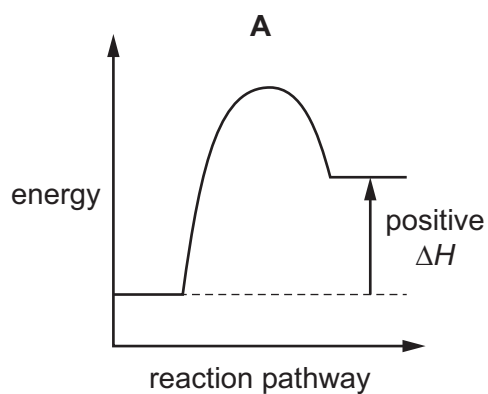

17 Which fraction of petroleum (crude oil) is used as a fuel in aircraft engines?

- A bitumen
- B naphtha
- C paraffin (kerosene)
- D petrol (gasoline)

18 The equation for photosynthesis is shown.

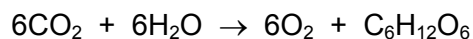

Which statement about photosynthesis is correct?

- A It has a negative enthalpy change.
- B It is catalysed by the presence of yeast.
- C The products of photosynthesis are oxygen and starch.
- D It occurs in green leaves.

19 Compound **X** reacts with an acid to produce sulfur dioxide gas.

A sample of **X** is placed in a flask and acid is added. The sulfur dioxide produced is collected and its volume is measured at various times.

A graph of the results is plotted.

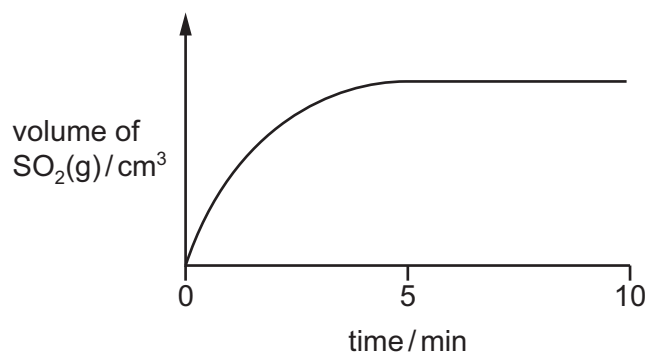

Which statement about this experiment is correct?

- A The gas can be collected by displacing water from a measuring cylinder.
- B The mass of the reaction flask and its contents decreases as the reaction proceeds.
- C The rate of the reaction increases as time increases.
- D The reaction is still proceeding after eight minutes.

20 Which reactions involve oxidation and reduction?

- 1 chlorine gas reacting with aqueous potassium iodide
- 2 dilute sulfuric acid reacting with magnesium
- 3 dilute hydrochloric acid reacting with aqueous sodium hydroxide

- A 1, 2 and 3
- B 1 and 2 only
- C 1 and 3 only
- D 2 and 3 only

21 Nitrogen reacts with oxygen in an equilibrium reaction.

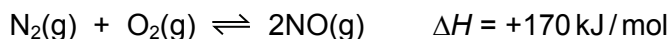

When the reaction is at equilibrium, which statement is correct?

- A The concentration of nitrogen present will change with time.
 - B The forward and backward reactions are taking place at the same rate.
 - C The forward reaction releases heat energy.
 - D There are more molecules on the left hand side of the equation than on the right.
- 22 Lead(II) oxide, PbO, reacts with dilute nitric acid, neutralising the acid. Lead(II) oxide also reacts with aqueous sodium hydroxide, neutralising the alkali.

Which word best describes lead(II) oxide?

- A acidic
 - B alkaline
 - C amphoteric
 - D basic
- 23 Which pair of reagents are most suitable for the laboratory preparation of copper(II) chloride?
- A aqueous copper(II) nitrate and aqueous sodium chloride
 - B copper and chlorine
 - C copper and dilute hydrochloric acid
 - D copper(II) oxide and dilute hydrochloric acid
- 24 The compounds shown can be used as nitrogenous fertilisers.

Which compound has the lowest percentage by mass of nitrogen?

- A $(\text{NH}_2)_2\text{CO}$ [M_r : 60]
- B $(\text{NH}_4)_2\text{SO}_4$ [M_r : 132]
- C $(\text{NH}_4)_3\text{PO}_4$ [M_r : 149]
- D NH_4NO_3 [M_r : 80]

29 Brass is an alloy.

Which statement about brass is correct?

- A It contains a sea of electrons.
- B It contains positive and negative ions which are free to move.
- C It is a compound of a metal and a non-metal.
- D It is a compound of two or more metals.

30 Copper(II) oxide reacts with carbon when heated.

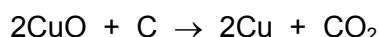

Which statement about this reaction is correct?

- A Carbon is the oxidising agent.
- B Carbon is the reducing agent.
- C Copper(II) oxide is oxidised.
- D Copper(II) oxide is the reducing agent.

31 The diagram shows a cell that can be used to extract a metal from its oxide.

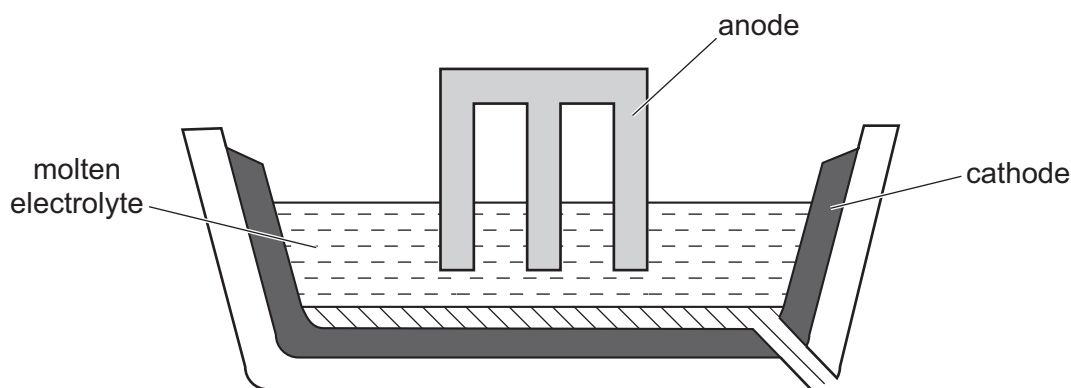

Molten aluminium oxide, copper(II) oxide, lead(II) oxide and magnesium oxide are each electrolysed in separate cells. Each cell receives the same number of electrons.

Which statement is correct?

- A All the metals can also be extracted from their oxides using coke.
- B The anode and cathode should be made of the metal being extracted.
- C The pure metal is always produced at the cathode.
- D The same mass of each metal is formed.

32 Iron is obtained in the blast furnace from the ore haematite.

Which process takes place in the blast furnace?

- A** Calcium carbonate is used to remove acidic impurities.
- B** Coke is reduced to carbon dioxide.
- C** Haematite is oxidised by carbon monoxide.
- D** Haematite undergoes thermal decomposition.

33 Aircraft manufacture requires a metal that:

- 1 has a relatively low density
- 2 is resistant to corrosion.

Which of these conditions does aluminium satisfy?

- A** 1 and 2
- B** 1 only
- C** 2 only
- D** neither 1 nor 2

34 Which pair of gases are both non-acidic?

- A** ammonia and methane
- B** carbon dioxide and ammonia
- C** methane and nitrogen dioxide
- D** nitrogen dioxide and carbon dioxide

35 Seawater is desalinated to make it drinkable.

What is the main substance removed by desalination?

- A** detergent
- B** fertiliser
- C** sewage
- D** sodium chloride

36 Which diagram shows a branched-chain isomer of butane?

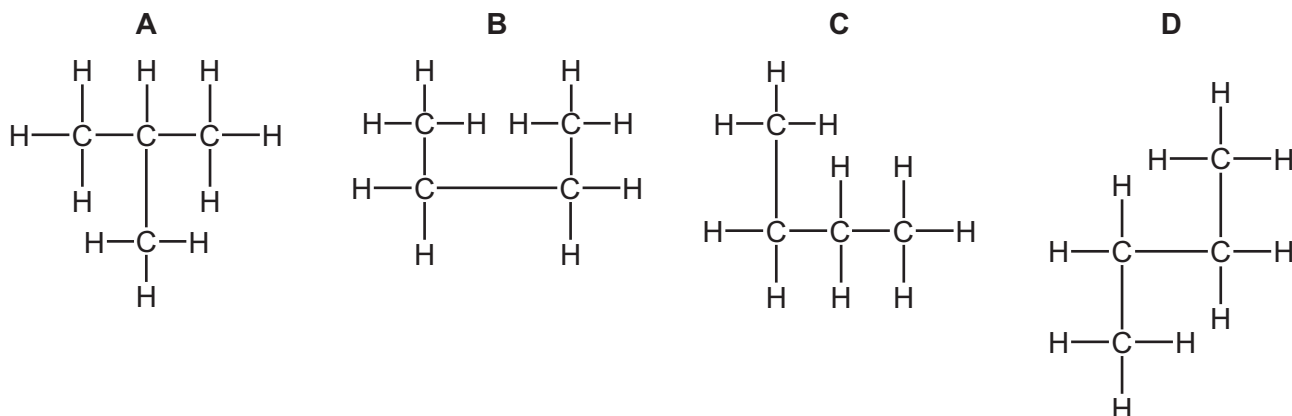

37 A straight-chain alkene, C_4H_8 , undergoes an addition reaction with bromine.

What is the possible structure of the product?

- A** $CH_3CHBrCH_2CH_2Br$
- B** $CH_3CHBrCHBrCH_3$
- C** $CH_2BrCH_2CH_2CH_2Br$
- D** $CH_3CH_2CH_2CH_2Br$

38 The diagram shows the structure of oxalic acid.

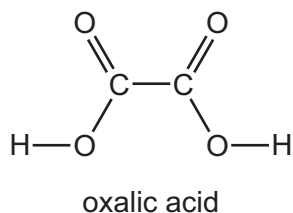

Which alcohol is oxidised to form oxalic acid?

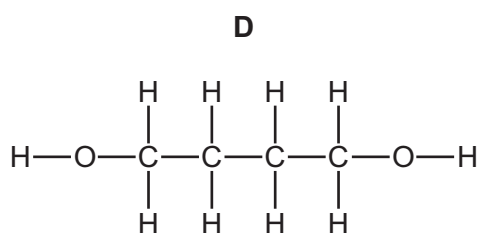
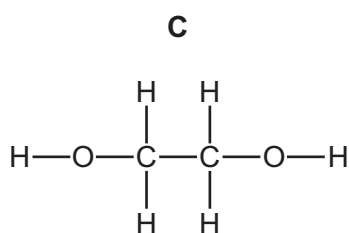
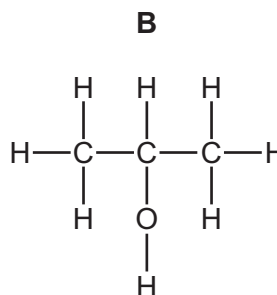
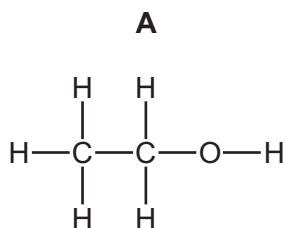

39 Some properties of compound **J** are listed.

- It reacts with potassium carbonate to produce carbon dioxide.
- It reacts with ethanol to produce a sweet-smelling liquid.
- It reacts with sodium hydroxide to produce a salt.

What is a possible identity of **J**?

- A** ethanoic acid
B ethanol
C ethyl ethanoate
D ethyl methanoate

40 The diagram shows the formula of nylon.

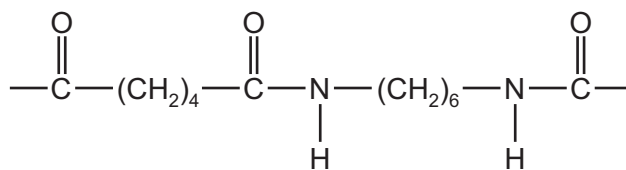

From which compounds could nylon be made?

- A $\text{HO}_2\text{C}-(\text{CH}_2)_6-\text{CO}_2\text{H}$ and $\text{H}_2\text{N}-(\text{CH}_2)_6-\text{NH}_2$
- B $\text{HO}_2\text{C}-(\text{CH}_2)_4-\text{CO}_2\text{H}$ and $\text{H}_2\text{N}-(\text{CH}_2)_4-\text{NH}_2$
- C $\text{HO}_2\text{C}-(\text{CH}_2)_4-\text{CO}_2\text{H}$ and $\text{H}_2\text{N}-(\text{CH}_2)_6-\text{NH}_2$
- D $\text{HO}_2\text{C}-(\text{CH}_2)_6-\text{CO}_2\text{H}$ and $\text{H}_2\text{N}-(\text{CH}_2)_4-\text{NH}_2$

Permission to reproduce items where third-party owned material protected by copyright is included has been sought and cleared where possible. Every reasonable effort has been made by the publisher (UCLES) to trace copyright holders, but if any items requiring clearance have unwittingly been included, the publisher will be pleased to make amends at the earliest possible opportunity.

To avoid the issue of disclosure of answer-related information to candidates, all copyright acknowledgements are reproduced online in the Cambridge International Examinations Copyright Acknowledgements Booklet. This is produced for each series of examinations and is freely available to download at www.cie.org.uk after the live examination series.

Cambridge International Examinations is part of the Cambridge Assessment Group. Cambridge Assessment is the brand name of University of Cambridge Local Examinations Syndicate (UCLES), which is itself a department of the University of Cambridge.

The Periodic Table of Elements

		Group															
I	II	III	IV	V	VI	VII	VIII					VIII					
3 Li lithium 7	4 Be beryllium 9	1 H hydrogen 1	5 B boron 11	6 C carbon 12	7 N nitrogen 14	8 O oxygen 16	9 F fluorine 19	10 Ne neon 20					18 Ar argon 40				
11 Na sodium 23	12 Mg magnesium 24	<p>Key</p> <p>atomic number</p> <p>atomic symbol</p> <p>name</p> <p>relative atomic mass</p>										16 S sulfur 32	17 Cl chlorine 35.5	18 Ar argon 40			
19 K potassium 39	20 Ca calcium 40	21 Sc scandium 45	22 Ti titanium 48	23 V vanadium 51	24 Cr chromium 52	25 Mn manganese 55	26 Fe iron 56	27 Co cobalt 59	28 Ni nickel 59	29 Cu copper 64	30 Zn zinc 65	31 Ga gallium 70	32 Ge germanium 73	33 As arsenic 75	34 Se selenium 79	35 Br bromine 80	36 Kr krypton 84
37 Rb rubidium 85	38 Sr strontium 88	39 Y yttrium 89	40 Zr zirconium 91	41 Nb niobium 93	42 Mo molybdenum 96	43 Tc technetium —	44 Ru ruthenium 101	45 Rh rhodium 103	46 Pd palladium 106	47 Ag silver 108	48 Cd cadmium 112	49 In indium 115	50 Sn tin 119	51 Sb antimony 122	52 Te tellurium 128	53 I iodine 127	54 Xe xenon 131
55 Cs caesium 133	56 Ba barium 137	57–71 lanthanoids	72 Hf hafnium 178	73 Ta tantalum 181	74 W tungsten 184	75 Re rhenium 186	76 Os osmium 190	77 Ir iridium 192	78 Pt platinum 195	79 Au gold 197	80 Hg mercury 201	81 Tl thallium 204	82 Pb lead 207	83 Bi bismuth 209	84 Po polonium —	85 At astatine —	86 Rn radon —
87 Fr francium —	88 Ra radium —	89–103 actinoids	104 Rf rutherfordium —	105 Db dubnium —	106 Sg seaborgium —	107 Bh bohrium —	108 Hs hassium —	109 Mt meitnerium —	110 Ds darmstadtium —	111 Rg roentgenium —	112 Cn copernicium —	114 Fl flerovium —	116 Lv livermorium —	116 Lv livermorium —	116 Lv livermorium —	116 Lv livermorium —	116 Lv livermorium —

lanthanoids	57 La lanthanum 139	58 Ce cerium 140	59 Pr praseodymium 141	60 Nd neodymium 144	61 Pm promethium —	62 Sm samarium 150	63 Eu europium 152	64 Gd gadolinium 157	65 Tb terbium 159	66 Dy dysprosium 163	67 Ho holmium 165	68 Er erbium 167	69 Tm thulium 169	70 Yb ytterbium 173	71 Lu lutetium 175
actinoids	89 Ac actinium —	90 Th thorium 232	91 Pa protactinium 231	92 U uranium 238	93 Np neptunium —	94 Pu plutonium —	95 Am americium —	96 Cm curium —	97 Bk berkelium —	98 Cf californium —	99 Es einsteinium —	100 Fm fermium —	101 Md mendelevium —	102 No nobelium —	103 Lr lawrencium —

The volume of one mole of any gas is 24 dm³ at room temperature and pressure (r.t.p.).