



Cambridge International AS & A Level

PHYSICS

9702/13

Paper 1 Multiple Choice

May/June 2020

1 hour 15 minutes

You must answer on the multiple choice answer sheet.

You will need: Multiple choice answer sheet
Soft clean eraser
Soft pencil (type B or HB is recommended)

INSTRUCTIONS

- There are **forty** questions on this paper. Answer **all** questions.
- For each question there are four possible answers **A, B, C** and **D**. Choose the **one** you consider correct and record your choice in soft pencil on the multiple choice answer sheet.
- Follow the instructions on the multiple choice answer sheet.
- Write in soft pencil.
- Write your name, centre number and candidate number on the multiple choice answer sheet in the spaces provided unless this has been done for you.
- Do **not** use correction fluid.
- Do **not** write on any bar codes.
- You may use a calculator.

INFORMATION

- The total mark for this paper is 40.
- Each correct answer will score one mark. A mark will not be deducted for a wrong answer.
- Any rough working should be done on this question paper.

This document has **24** pages. Blank pages are indicated.



2

Data

speed of light in free space	$c = 3.00 \times 10^8 \text{ m s}^{-1}$
permeability of free space	$\mu_0 = 4\pi \times 10^{-7} \text{ H m}^{-1}$
permittivity of free space	$\epsilon_0 = 8.85 \times 10^{-12} \text{ F m}^{-1}$ $(\frac{1}{4\pi\epsilon_0} = 8.99 \times 10^9 \text{ m F}^{-1})$
elementary charge	$e = 1.60 \times 10^{-19} \text{ C}$
the Planck constant	$h = 6.63 \times 10^{-34} \text{ J s}$
unified atomic mass unit	$1 \text{ u} = 1.66 \times 10^{-27} \text{ kg}$
rest mass of electron	$m_e = 9.11 \times 10^{-31} \text{ kg}$
rest mass of proton	$m_p = 1.67 \times 10^{-27} \text{ kg}$
molar gas constant	$R = 8.31 \text{ J K}^{-1} \text{ mol}^{-1}$
the Avogadro constant	$N_A = 6.02 \times 10^{23} \text{ mol}^{-1}$
the Boltzmann constant	$k = 1.38 \times 10^{-23} \text{ J K}^{-1}$
gravitational constant	$G = 6.67 \times 10^{-11} \text{ N m}^2 \text{ kg}^{-2}$
acceleration of free fall	$g = 9.81 \text{ m s}^{-2}$

Formulae

uniformly accelerated motion	$s = ut + \frac{1}{2}at^2$ $v^2 = u^2 + 2as$
work done on/by a gas	$W = p\Delta V$
gravitational potential	$\phi = -\frac{Gm}{r}$
hydrostatic pressure	$p = \rho gh$
pressure of an ideal gas	$p = \frac{1}{3} \frac{Nm}{V} \langle c^2 \rangle$
simple harmonic motion	$a = -\omega^2 x$
velocity of particle in s.h.m.	$v = v_0 \cos \omega t$ $v = \pm \omega \sqrt{(x_0^2 - x^2)}$
Doppler effect	$f_o = \frac{f_s v}{v \pm v_s}$
electric potential	$V = \frac{Q}{4\pi\epsilon_0 r}$
capacitors in series	$1/C = 1/C_1 + 1/C_2 + \dots$
capacitors in parallel	$C = C_1 + C_2 + \dots$
energy of charged capacitor	$W = \frac{1}{2}QV$
electric current	$I = Anvq$
resistors in series	$R = R_1 + R_2 + \dots$
resistors in parallel	$1/R = 1/R_1 + 1/R_2 + \dots$
Hall voltage	$V_H = \frac{BI}{ntq}$
alternating current/voltage	$x = x_0 \sin \omega t$
radioactive decay	$x = x_0 \exp(-\lambda t)$
decay constant	$\lambda = \frac{0.693}{t_{\frac{1}{2}}}$

- 1 A man is running a race in a straight line.

What is an approximate value of his kinetic energy?

- A 10 J B 100 J C 1000 J D 10000 J

- 2 A sample of gas has a mass of $4.8 \mu\text{g}$ and occupies a volume of 1.2 dm^3 .

What is the density of the sample of gas?

- A $4.0 \times 10^{-3} \text{ kg m}^{-3}$
 B $4.0 \times 10^{-5} \text{ kg m}^{-3}$
 C $4.0 \times 10^{-6} \text{ kg m}^{-3}$
 D $4.0 \times 10^{-8} \text{ kg m}^{-3}$

- 3 Which characteristics are possessed by a vector quantity but **not** by a scalar quantity?

- A direction only
 B magnitude and direction
 C magnitude and unit
 D unit only

- 4 A circuit is set up in order to determine the resistance of a 12 V, 1.2 W lamp when operating normally. An analogue ammeter and an analogue voltmeter are used.

Which ranges for the meters would be most suitable?

	ammeter range /A	voltmeter range /V
A	0–0.5	0–20
B	0–0.5	0–100
C	0–10	0–20
D	0–10	0–100

- 5 Two liquid-in-glass thermometers in a well-mixed liquid are individually observed by 10 different students. All agree that one thermometer reads 21°C and the other thermometer reads 23°C .

What is a possible explanation for the difference?

- A The liquid is not all at the same temperature.
 B The readings are not precise.
 C There is a random error affecting the readings.
 D There is a systematic error affecting the readings.

- 6 The graph shows how the velocity of a ball varies with time from the moment it is hit vertically upwards from the ground.

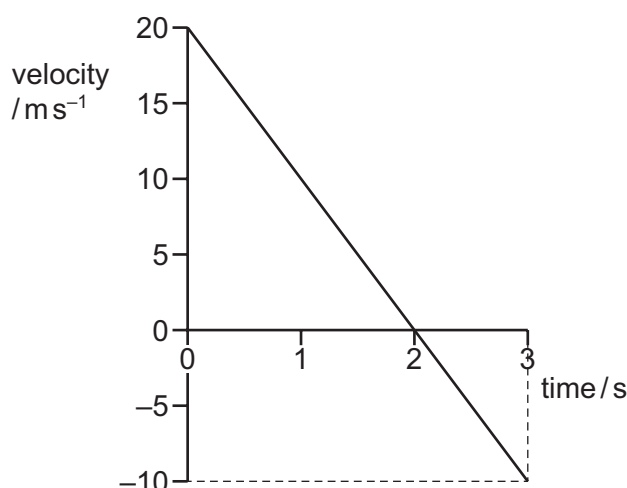

What is the displacement of the ball from the ground after a time of 3.0 s?

- A** 15 m **B** 25 m **C** 30 m **D** 45 m
- 7 Two students each throw a ball horizontally from the top of a tower. The two balls are released at the same time.

The first student throws her ball with a speed of 20 m s^{-1} and the second student throws his ball with a speed of 10 m s^{-1} .

Assume air resistance is negligible and that the balls land on horizontal ground.

Which row describes the horizontal distances travelled and the landing times of the two balls on the ground?

	horizontal distances	landing times
A	same	same
B	same	different
C	different	same
D	different	different

- 8 A ball of mass m travels vertically downwards and then hits a horizontal floor at speed u .
It rebounds vertically upwards with speed v .

The collision lasts a time Δt .

What is the average resultant force exerted on the ball during the collision?

- A $\frac{mv - mu}{\Delta t}$ downwards
 B $\frac{mv - mu}{\Delta t}$ upwards
 C $\frac{mv + mu}{\Delta t}$ downwards
 D $\frac{mv + mu}{\Delta t}$ upwards
- 9 The resultant force F on a raindrop of mass m falling vertically with velocity v is given by the equation

$$F = mg - kv^2$$

where k is a constant and g is the acceleration of free fall.

The falling raindrop eventually reaches a constant (terminal) velocity.

Which graph shows the variation of the terminal velocity of the raindrop with mass m ?

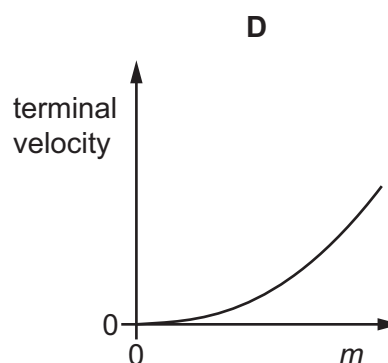
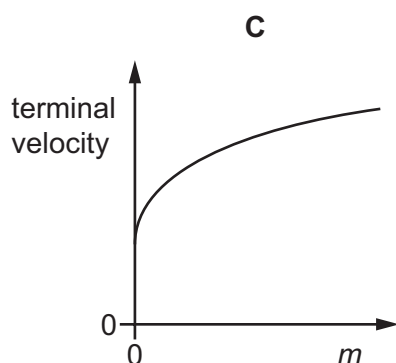
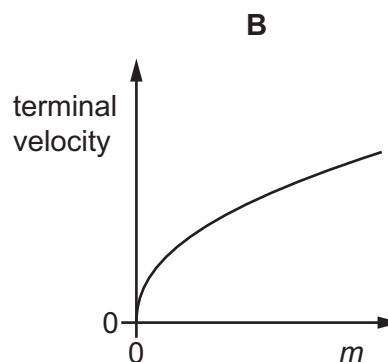
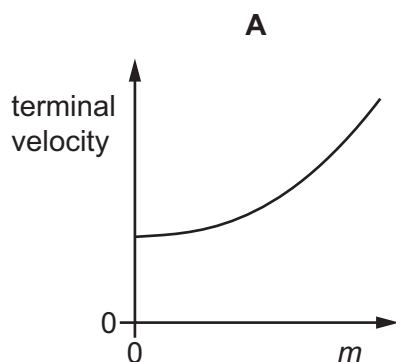

- 10 A ball of mass m , moving at a velocity v , collides with a stationary ball of mass $2m$.

The two balls stick together.

Which fraction of the initial kinetic energy is lost on impact?

- A $\frac{1}{9}$ B $\frac{1}{3}$ C $\frac{2}{3}$ D $\frac{8}{9}$

- 11 A submarine is in equilibrium in a fully submerged position.

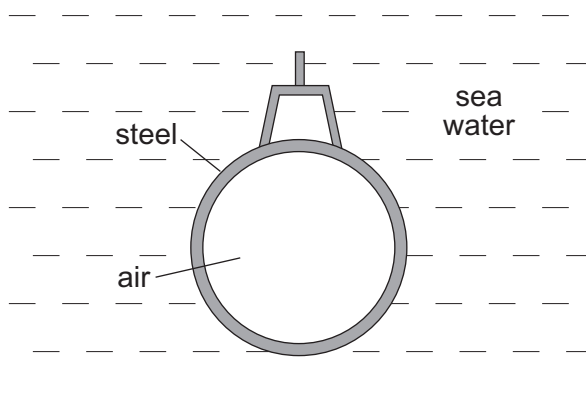

What causes the upthrust on the submarine?

- A The air in the submarine is less dense than sea water.
 B There is a difference in water pressure acting on the top and on the bottom of the submarine.
 C The sea water exerts a greater upward force on the submarine than the weight of the steel.
 D The submarine displaces its own volume of sea water.
- 12 Two forces, each of magnitude F , act along the edges of a rectangular metal plate, as shown.

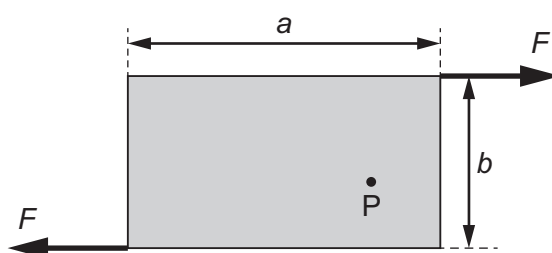

The plate has length a and width b .

What is the torque about point P?

- A Fa B Fb C $2Fa$ D $2Fb$

- 13 A non-uniform rod has a mass of 100 g and a length of 50 cm. It is supported by a chain at its midpoint. The rod is held in equilibrium by having a mass of 60 g suspended from its right-hand end, as shown.

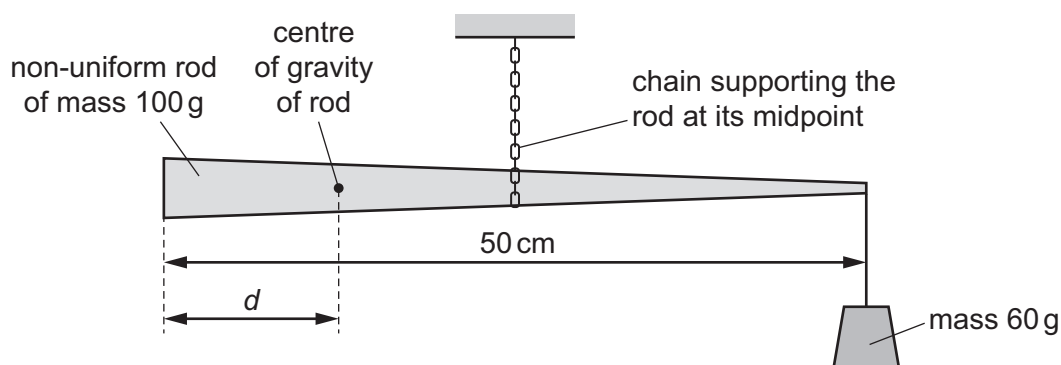

The centre of gravity of the rod is a distance d from its left-hand end.

What is the value of d ?

- A 10 cm B 15 cm C 25 cm D 40 cm
- 14 A light rigid rod XY has an object of weight W fixed at one end. The rod is in equilibrium, resting on a support at Z and a vertical wall at X. The support exerts a force R on the rod as shown. The diagram shows the directions, but not the magnitudes, of the forces R and W .

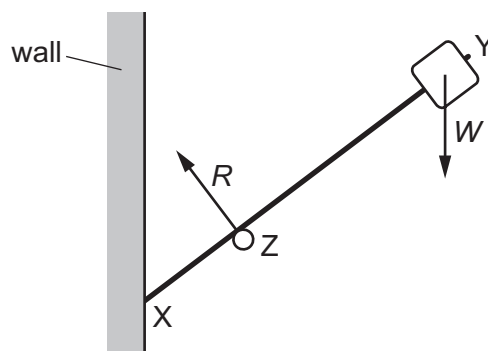

What is the direction of the force on the rod at X?



- 15 Liquid Q has twice the density of liquid R.

At depth x in liquid R, the pressure due to the liquid is 4 kPa.

At which depth in liquid Q is the pressure due to the liquid 7 kPa?

- A $\frac{2x}{7}$ B $\frac{7x}{8}$ C $\frac{8x}{7}$ D $\frac{7x}{2}$

16 A trolley starts from rest at X. It rolls down to Y and eventually comes to rest at Z.

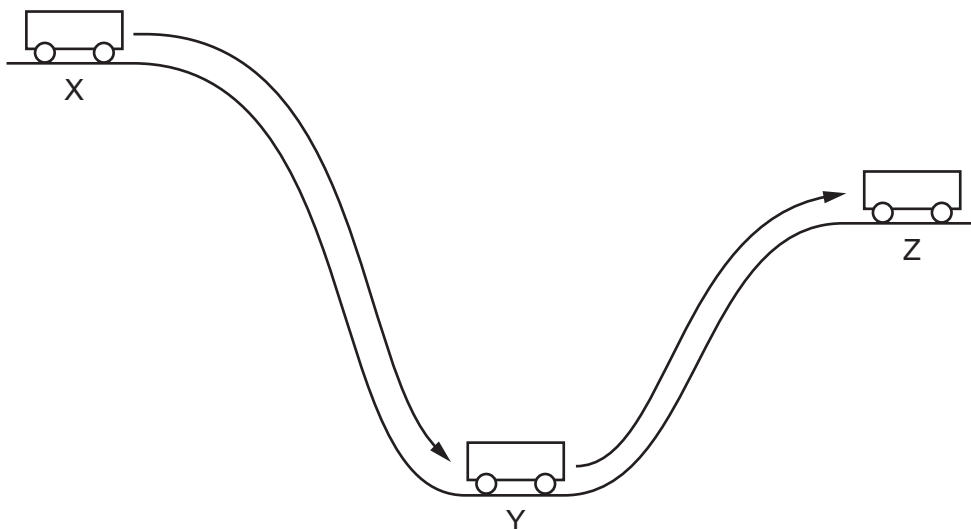

Which row is a possible summary of the energy changes during this process?

	X to Y	Y to Z
A	PE → KE	KE → PE
B	PE → KE	KE → PE + heat
C	PE → KE + heat	KE → PE
D	PE → KE + heat	KE → PE + heat

key

PE = potential energy

KE = kinetic energy

17 A cylinder is heated, causing the air inside to expand at a constant pressure of 2.2×10^5 Pa.

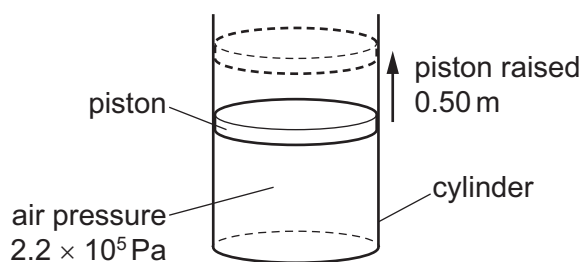

The expansion of the air causes the piston to rise through a vertical distance of 0.50 m, doing 11 kJ of work. Frictional forces are negligible.

What is the cross-sectional area of the piston?

- A** $1.0 \times 10^{-4} \text{ m}^2$
- B** $2.5 \times 10^{-2} \text{ m}^2$
- C** $5.0 \times 10^{-2} \text{ m}^2$
- D** $1.0 \times 10^{-1} \text{ m}^2$

18 A ball slides down a curved track, as shown.

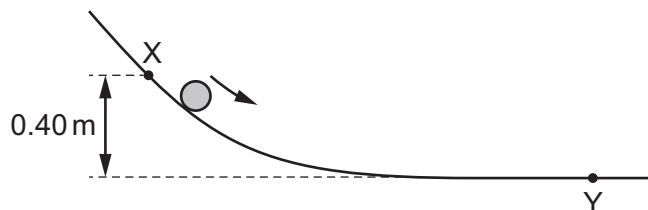

Point X is at a height of 0.40 m above point Y. The speed of the ball at point X is 2.5 m s^{-1} .

Frictional forces are negligible.

What is the speed of the ball at point Y?

- A 2.8 m s^{-1} B 3.2 m s^{-1} C 3.8 m s^{-1} D 14 m s^{-1}

19 The force diagram shows an aircraft accelerating. At the instant shown, the velocity of the aircraft is 40 m s^{-1} .

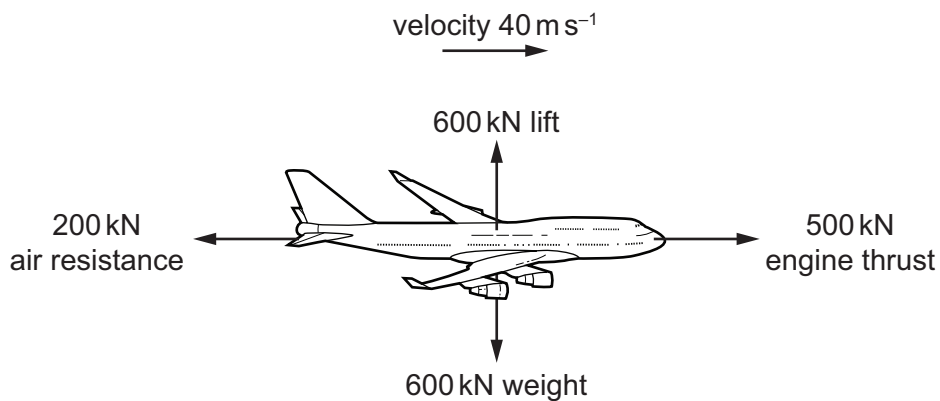

At which rate is its kinetic energy increasing?

- A 2.4 MW B 8.0 MW C 12 MW D 20 MW

20 The diagram shows a simplified model of a building with four identical heavy floors.

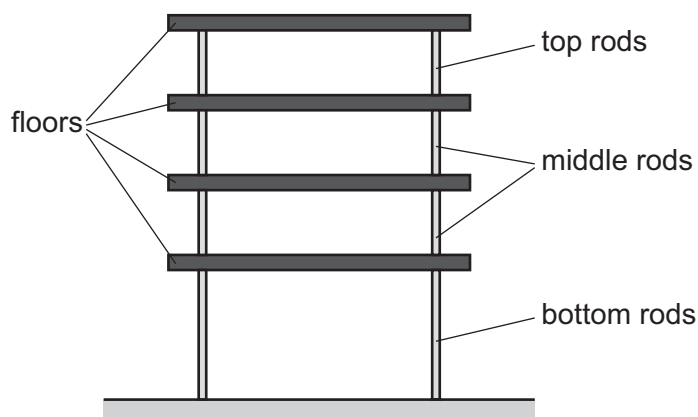

The spacing of the bottom floor from the ground is twice that of the spacing between the floors. Between each floor are equal numbers of vertical steel supporting rods of negligible mass compared with the floors. The rods are of different diameters so that the stress in each rod is the same.

What is the ratio $\frac{\text{diameter of bottom rods}}{\text{diameter of top rods}}$?

- A** 2 **B** 4 **C** 8 **D** 16

21 The Achilles tendon in a rabbit's leg is stretched when the rabbit jumps.

The graph shows the variation with tension of the length of the tendon.

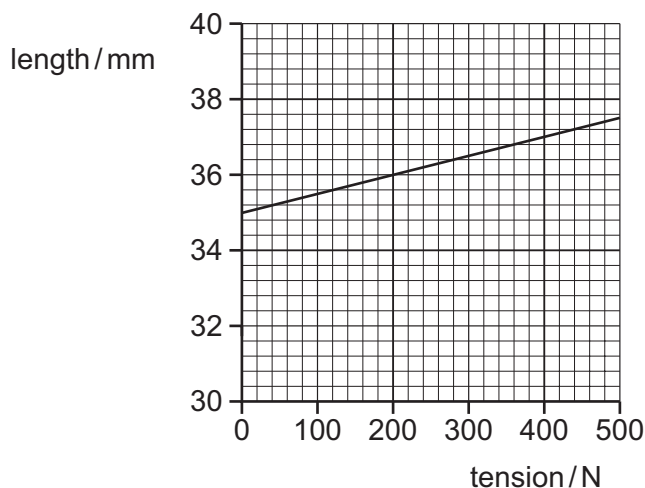

What is the strain energy in the tendon when the tension is 400 N?

- A** 0.40 J **B** 0.80 J **C** 2.4 J **D** 7.4 J

22 A wave of amplitude A has an intensity I .

After passing through a certain medium, the wave has a new intensity of $\frac{I}{4}$.

What is the new amplitude of the wave?

- A $2A$ B $\frac{A}{2}$ C $\frac{A}{4}$ D $\frac{A}{16}$

23 A wave travels along a coiled spring.

The graph shows the variation with time of the displacement of a point on the spring.

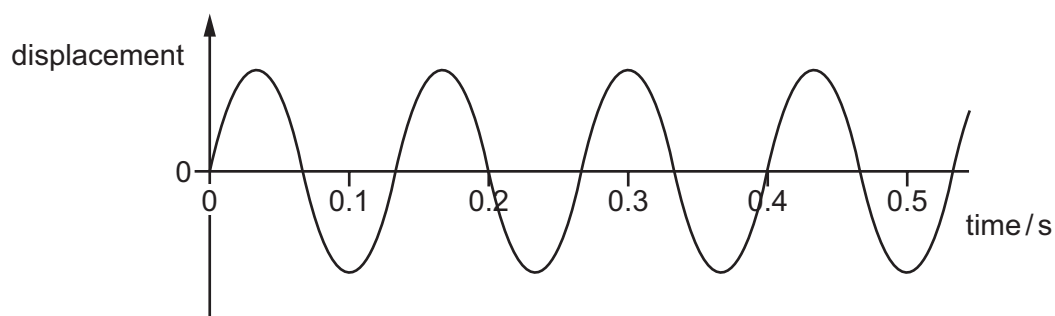

What is the frequency of the wave?

- A 0.13 Hz B 0.20 Hz C 5.0 Hz D 7.5 Hz

24 A loudspeaker is set up at the open end of a closed tube containing powder.

When the loudspeaker produces sound of frequency 1200 Hz, a stationary wave is produced in the tube. The powder gathers at the nodes of the stationary wave as shown.

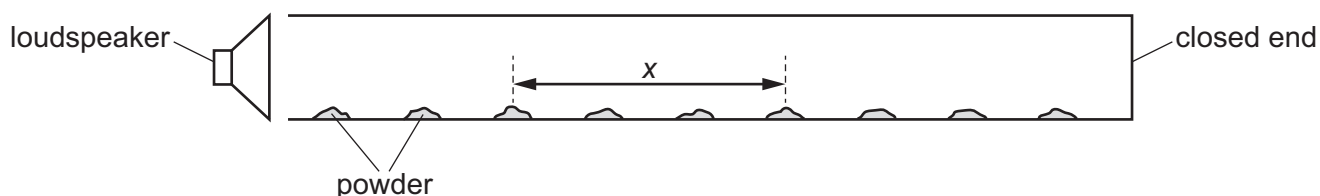

The speed of sound in the air is 336 m s^{-1} .

What is the value of distance x ?

- A 28 cm B 42 cm C 84 cm D 112 cm

25 A stationary source S emits a sound wave of frequency f .

The source now moves away from a stationary observer.

Which statement is correct?

- A The frequency of the source S and the observed frequency are now both higher than f .
- B The frequency of the source S and the observed frequency are now both lower than f .
- C The frequency of the source S is now lower than f .
- D The observed frequency is now lower than f .

26 The table lists possible wavelengths of four different electromagnetic waves.

Which row is correct?

	type of wave	approximate wavelength / m
A	infrared	10^{-5}
B	radio	10^{-3}
C	ultraviolet	10^{-12}
D	X-rays	10^{-7}

- 27 A vertical tube is partially filled with water. A sound wave moves down the tube and is reflected by the surface of the water. The frequency of the sound wave is gradually increased from zero until a much louder sound is heard.

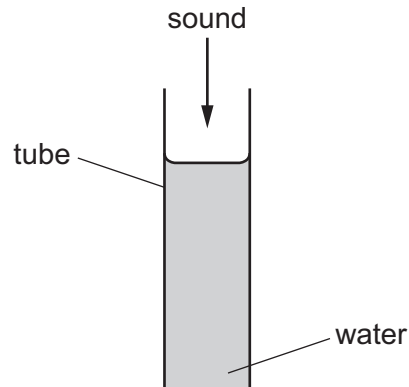

Water is then removed from the tube until a second louder sound is heard.

Which diagram shows the new pattern of the stationary wave that is formed?

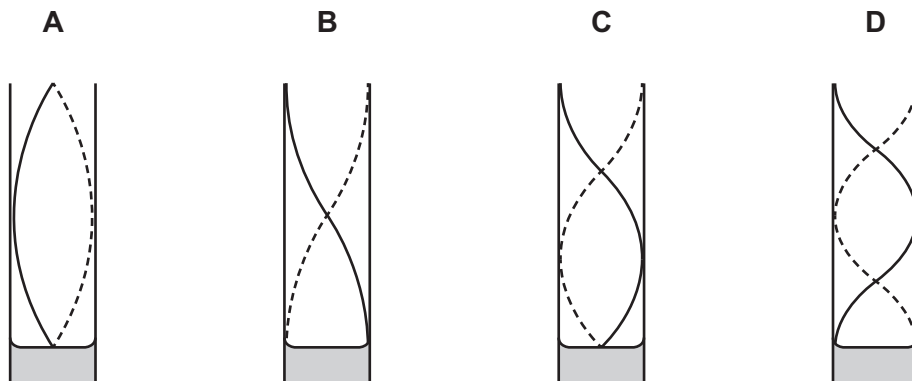

28 Water waves in a ripple tank are made to pass through a small gap as shown.

Which diagram shows the waves after they have passed through the gap?

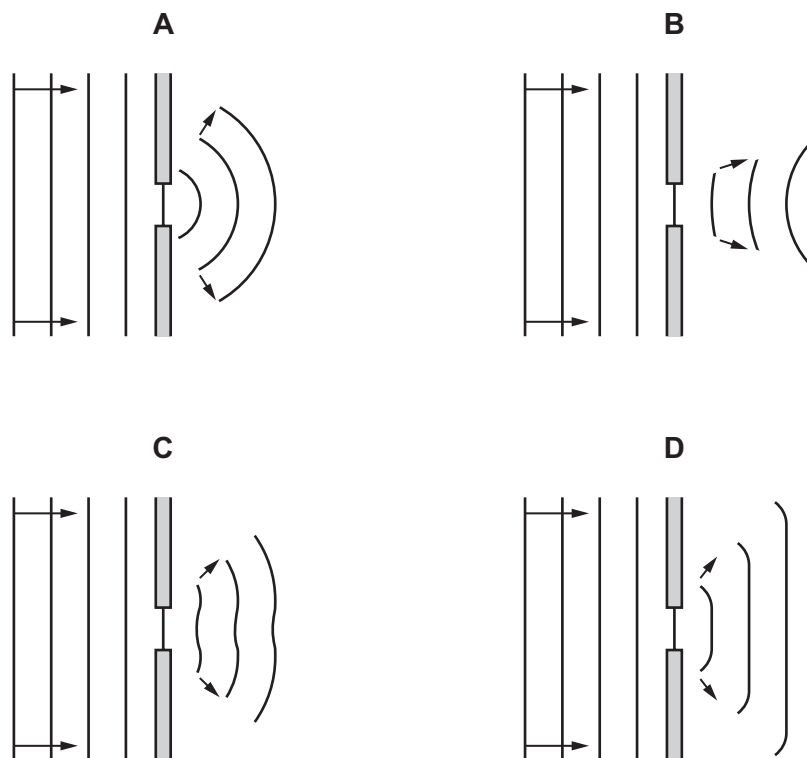

29 A double-slit interference experiment is set up using green light.

A pattern of interference fringes is formed on a screen.

Which single change will increase the separation of the fringes?

- A increase the width of each slit
- B move the screen nearer to the double slit
- C use slits that are further apart
- D use red light instead of green light

30 Light of a single wavelength from a distant point source falls normally onto a diffraction grating positioned with its lines vertical.

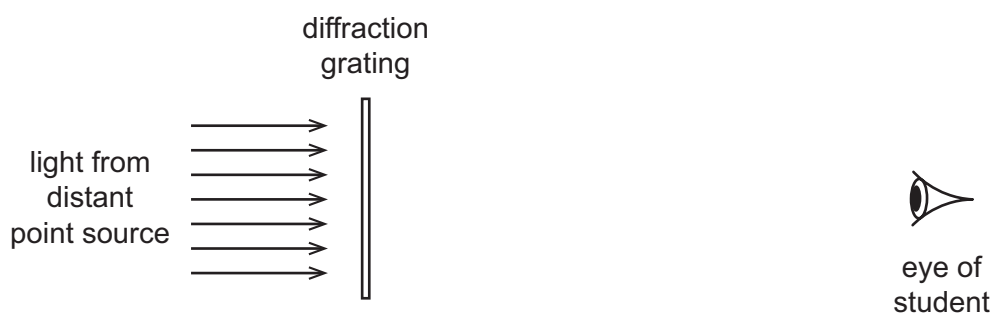

NOT TO SCALE

The plane of the diffraction grating is at right angles to the incident light. A student looks at the grating from a position near to the grating.

What could the student see?

- A a central point source with a series of point source images on either side
- B a central vertical line with a series of spectra on either side
- C a series of fine vertical lines
- D a single point source

31 Which diagram best represents the electric field between two point charges of equal magnitude and opposite sign?

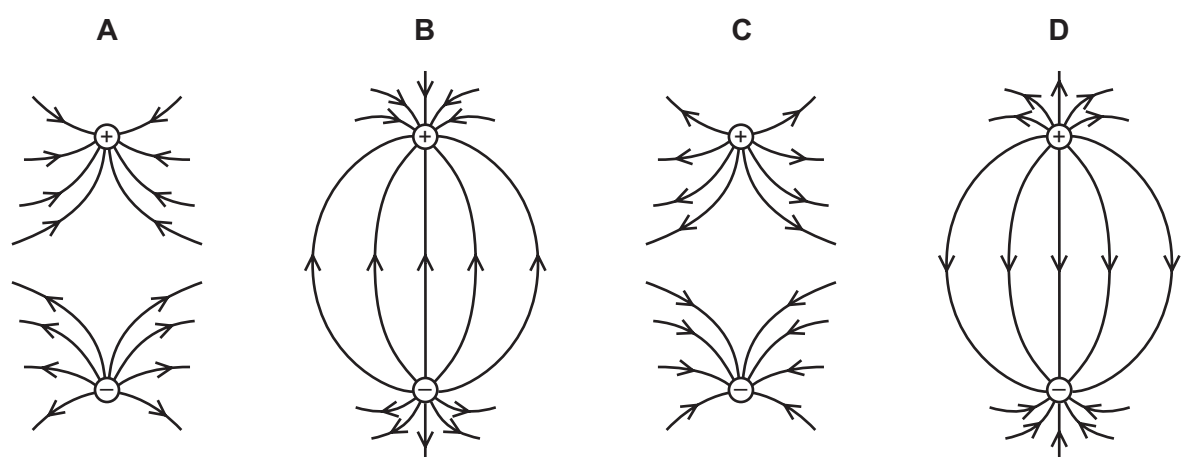

- 32 A negatively charged oil drop of mass m is between two horizontal parallel metal plates distance d apart.

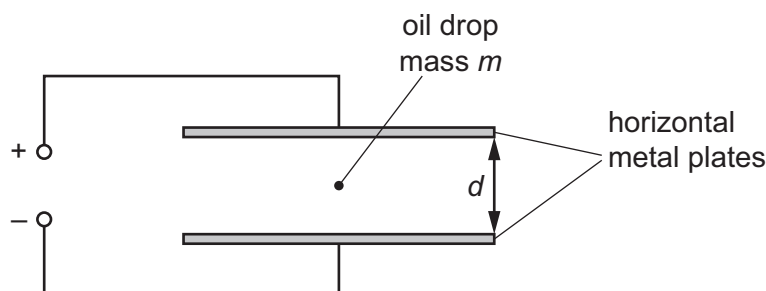

When the potential difference (p.d.) between the plates is V_1 the oil drop rises at a constant speed. When the p.d. is decreased to a value V_2 the oil drop falls at the same constant speed.

Air resistance acts on the drop when it is moving. The upthrust on the drop is negligible.

The acceleration of free fall is g .

What is the charge on the oil drop?

- A $\frac{mdg}{V_1 - V_2}$ B $\frac{mdg}{V_1 + V_2}$ C $\frac{2mdg}{V_1 - V_2}$ D $\frac{2mdg}{V_1 + V_2}$

- 33 The unit of electric charge is the coulomb.

What is meant by 1 coulomb?

- A the charge passing a point in 1 second when a current produces 1 joule of work
 B the charge passing a point in 1 second when a current produces 1 watt of power
 C the charge passing a point in 1 second when there is a current of 1 ampere
 D the charge passing a point in 1 second when there is 1 ohm of resistance

- 34 Two copper wires are joined together and carry a current, as shown.

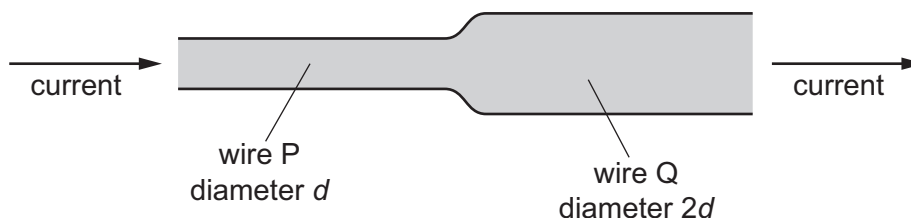

Wire P has diameter d and wire Q has diameter $2d$.

What is the ratio $\frac{\text{average drift speed of the free electrons in wire P}}{\text{average drift speed of the free electrons in wire Q}}$?

- A $\frac{1}{4}$ B $\frac{1}{2}$ C 2 D 4

- 35 A power supply of electromotive force (e.m.f.) V and negligible internal resistance is connected to the circuit shown. There is a current of 3.0 A in the $4.0\ \Omega$ resistor.

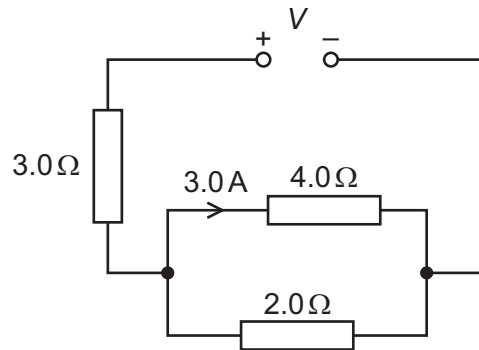

What is the value of V ?

- A 15V B 29V C 39V D 51V
- 36 The wire of a heating element has resistance R . The wire breaks and is replaced by a different wire.

Data for the original wire and for the replacement wire are shown in the table.

	length	diameter	resistivity of metal
original wire	l	d	ρ
replacement wire	l	$2d$	2ρ

What is the resistance of the replacement wire?

- A $\frac{R}{4}$ B $\frac{R}{2}$ C R D $2R$

- 37 A fixed resistor and a variable resistor are connected in series with a cell that has an internal resistance, as shown.

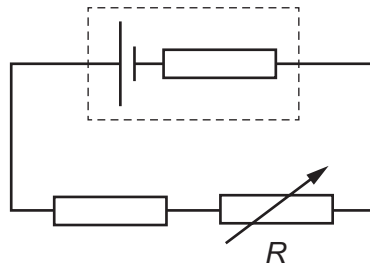

The graph shows the variation of a quantity X with the resistance R of the variable resistor as R is increased from zero to its maximum value.

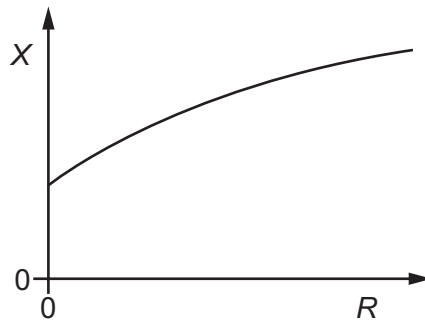

What could X represent?

- A the current in the circuit
- B the electromotive force of the cell
- C the potential difference across the internal resistance
- D the terminal potential difference across the cell

- 38 A cell of electromotive force (e.m.f.) 4.0V and negligible internal resistance is connected to a fixed resistor of resistance 1.0Ω and a potentiometer of maximum resistance 3.0Ω , as shown.

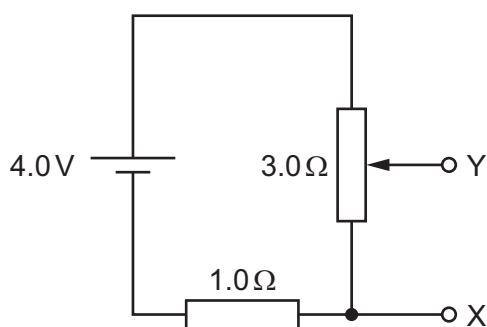

Which range of potential differences can be obtained between the terminals X and Y?

- A 0V to 3.0V
 B 0V to 4.0V
 C 1.0V to 3.0V
 D 1.0V to 4.0V
- 39 Radiation from a radioactive source has a range of a few millimetres in air and can be deflected by an electric field.

Which type of radiation is being emitted?

- A α -radiation
 B β^- radiation
 C β^+ radiation
 D γ -rays
- 40 Which equation describes the process of β^+ decay?

key:

u = up quark

d = down quark

ν = (electron) neutrino

$\bar{\nu}$ = (electron) antineutrino

- A $ddu \rightarrow uud + \beta^+ + \nu$
 B $ddu \rightarrow uud + \beta^+ + \bar{\nu}$
 C $uud \rightarrow ddu + \beta^+ + \nu$
 D $uud \rightarrow ddu + \beta^+ + \bar{\nu}$

BLANK PAGE

BLANK PAGE

BLANK PAGE

BLANK PAGE

Permission to reproduce items where third-party owned material protected by copyright is included has been sought and cleared where possible. Every reasonable effort has been made by the publisher (UCLES) to trace copyright holders, but if any items requiring clearance have unwittingly been included, the publisher will be pleased to make amends at the earliest possible opportunity.

To avoid the issue of disclosure of answer-related information to candidates, all copyright acknowledgements are reproduced online in the Cambridge Assessment International Education Copyright Acknowledgements Booklet. This is produced for each series of examinations and is freely available to download at www.cambridgeinternational.org after the live examination series.

Cambridge Assessment International Education is part of the Cambridge Assessment Group. Cambridge Assessment is the brand name of the University of Cambridge Local Examinations Syndicate (UCLES), which itself is a department of the University of Cambridge.