

Cambridge
International
AS & A Level

Cambridge International Examinations
Cambridge International Advanced Subsidiary and Advanced Level

CANDIDATE
NAME

CENTRE
NUMBER

--	--	--	--	--	--

CANDIDATE
NUMBER

--	--	--	--

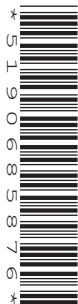

PHYSICS

9702/34

Paper 3 Advanced Practical Skills 2

October/November 2018

2 hours

Candidates answer on the Question Paper.

Additional Materials: As listed in the Confidential Instructions.

READ THESE INSTRUCTIONS FIRST

Write your Centre number, candidate number and name on all the work you hand in.
Write in dark blue or black pen.
You may use an HB pencil for any diagrams or graphs.
Do not use staples, paper clips, glue or correction fluid.
DO NOT WRITE IN ANY BARCODES.

Answer **both** questions.

You will be allowed to work with the apparatus for a maximum of one hour for each question.
You are expected to record all your observations as soon as these observations are made, and to plan the presentation of the records so that it is not necessary to make a fair copy of them.
You are reminded of the need for good English and clear presentation in your answers.

Electronic calculators may be used.

You may lose marks if you do not show your working or if you do not use appropriate units.

Additional answer paper and graph paper should be used only if it becomes necessary to do so.

At the end of the examination, fasten all your work securely together.

The number of marks is given in brackets [] at the end of each question or part question.

For Examiner's Use	
1	
2	
Total	

This document consists of **11** printed pages and **1** blank page.

You may not need to use all of the materials provided.

1 In this experiment, you will investigate an electrical circuit.

(a) • You have been provided with the circuit shown in Fig. 1.1.

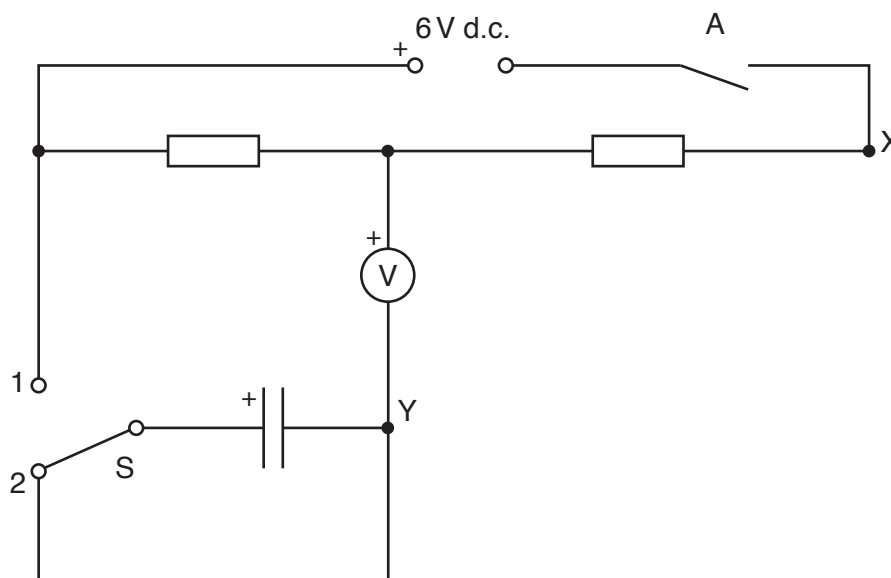

Fig. 1.1

- Select one of the groups of parallel resistors and connect it in the component holder.
- Connect the resistor R and the component holder in series between X and Y to complete the circuit shown in Fig. 1.2.

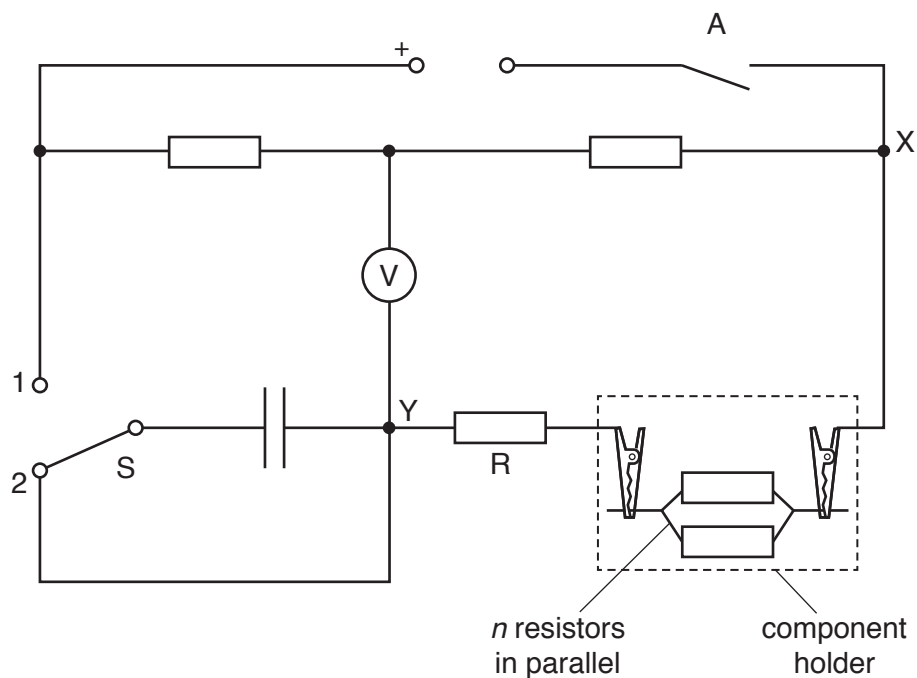

Fig. 1.2

- Ensure that switch S is in position 2.

3

- Record the number n of parallel resistors in the component holder.

$n =$

- Close switch A.
- Record the voltmeter reading V .

$V =$

- Open A.

[1]

- (b) • Close A.

- Move S to position 1 and start the stopwatch. The voltmeter reading will immediately become negative and then gradually increase.
- Stop the stopwatch as soon as the voltmeter reading passes zero and becomes positive.
- Record the time t as shown by the stopwatch.

$t =$

- Move S to position 2.
- Open A.

[2]



- (c) By using different groups of resistors, change n and repeat (b) until you have six sets of values of n and t .

Record your results in a table. Include values of $\frac{1}{n}$ in your table.

- (d) (i) Plot a graph of t on the y -axis against $\frac{1}{n}$ on the x -axis. [9]
- (ii) Draw the straight line of best fit. [3]
- (iii) Determine the gradient and y -intercept of this line. [1]

gradient =

y -intercept =

[2]

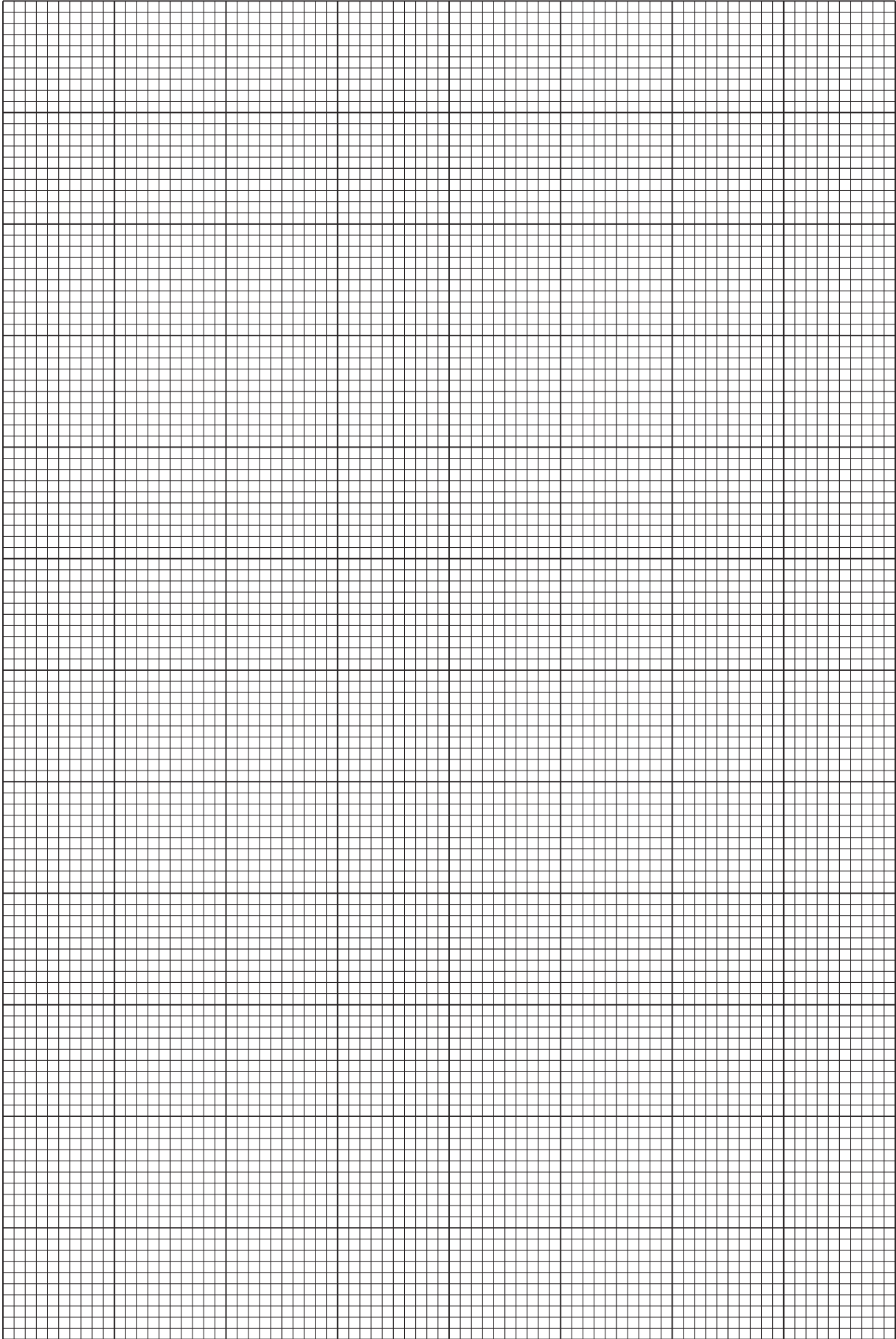

(e) It is suggested that the quantities t and n are related by the equation

$$t = \frac{a}{n} + b$$

where a and b are constants.

Use your answers in (d)(iii) to determine the values of a and b .
Give appropriate units.

$a =$

$b =$

[2]

[Total: 20]

You may not need to use all of the materials provided.

2 In this experiment, you will investigate the rolling of a sphere along tracks of different widths.

(a) (i) Measure and record the diameter d of the sphere.

$d = \dots\dots\dots$ [1]

(ii) • Measure and record the width w of the narrower track, as shown in Fig. 2.1.

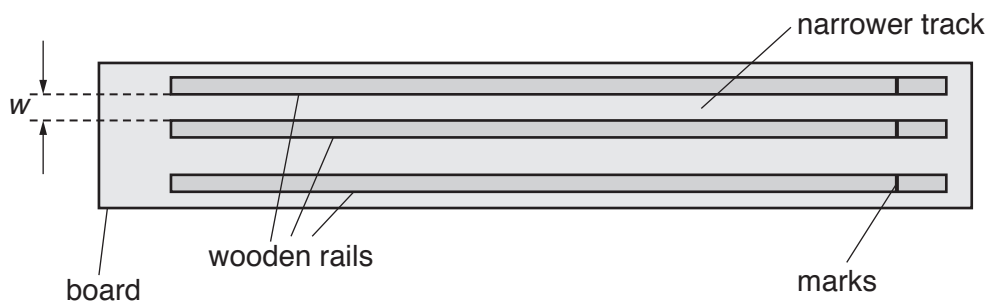

Fig. 2.1 (not to scale)

$w = \dots\dots\dots$

• Calculate D^2 where $D^2 = d^2 - w^2$.

$D^2 = \dots\dots\dots$ [1]

(b) (i) • Place the board on the bench. Raise the end of the board with the marks by resting it on a wooden block. Place the other wooden block across the lower end of the board, as shown in Fig. 2.2. Secure the blocks in position with small pieces of Blu-Tack.

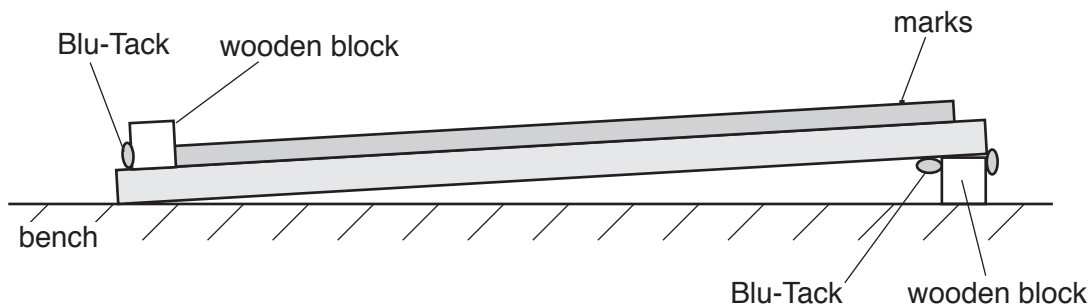

Fig. 2.2 (not to scale)

- Measure and record the distance x from the wooden block at the lower end of the board to the mark on the middle rail, as shown in Fig. 2.3.

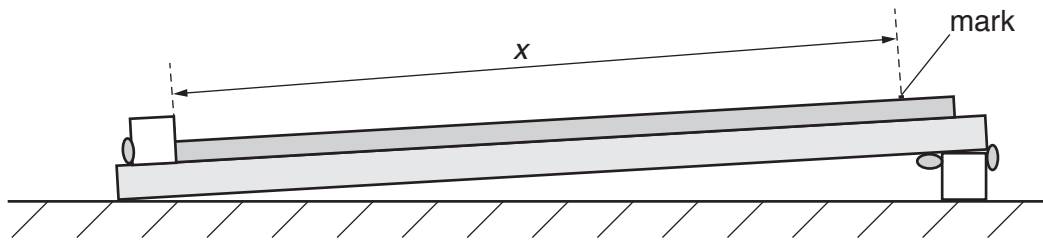

Fig 2.3 (not to scale)

$x = \dots\dots\dots$ [1]

- (ii) • Place the sphere on the narrower track at the position shown in Fig. 2.4.

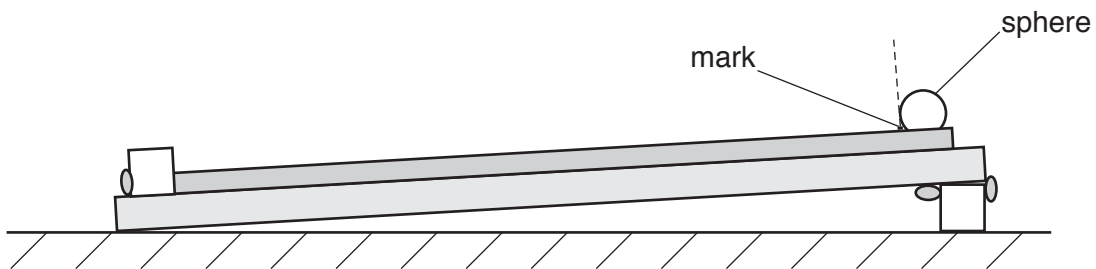

Fig. 2.4 (not to scale)

- Release the sphere.
- Measure and record the time t for the sphere to roll down to the lower wooden block.

$t = \dots\dots\dots$ [1]

- (iii) Estimate the percentage uncertainty in your value of t .

percentage uncertainty = $\dots\dots\dots$ [1]

(iv) Calculate the final speed v of the sphere, using

$$v = \frac{2x}{t}.$$

$v =$ [1]

(v) Justify the number of significant figures you have given for your value of v .

.....
.....
..... [1]

(c) Repeat (a)(ii), (b)(ii) and (b)(iv) using the **wider** of the two tracks.

$w =$

$D^2 =$

$t =$

$v =$ [3]

(d) It is suggested that the relationship between v , d and D is

$$k = v^2 \left(10 + \frac{d^2}{D^2} \right)$$

where k is a constant.

(i) Using your data, calculate two values of k .

first value of $k = \dots\dots\dots$

second value of $k = \dots\dots\dots$

[1]

(ii) Explain whether your results support the suggested relationship.

.....
.....
.....
.....[1]

(e) (i) Describe four sources of uncertainty or limitations of the procedure for this experiment.

1.
.....
2.
.....
3.
.....
4.
.....

[4]

(ii) Describe four improvements that could be made to this experiment. You may suggest the use of other apparatus or different procedures.

1.
.....
2.
.....
3.
.....
4.
.....

[4]

[Total: 20]

Permission to reproduce items where third-party owned material protected by copyright is included has been sought and cleared where possible. Every reasonable effort has been made by the publisher (UCLES) to trace copyright holders, but if any items requiring clearance have unwittingly been included, the publisher will be pleased to make amends at the earliest possible opportunity.

To avoid the issue of disclosure of answer-related information to candidates, all copyright acknowledgements are reproduced online in the Cambridge International Examinations Copyright Acknowledgements Booklet. This is produced for each series of examinations and is freely available to download at www.cie.org.uk after the live examination series.

Cambridge International Examinations is part of the Cambridge Assessment Group. Cambridge Assessment is the brand name of University of Cambridge Local Examinations Syndicate (UCLES), which is itself a department of the University of Cambridge.