

Cambridge  
International  
AS & A Level

**Cambridge International Examinations**  
Cambridge International Advanced Subsidiary and Advanced Level

---

**PHYSICS**

**9702/12**

Paper 1 Multiple Choice

**May/June 2017**

**1 hour 15 minutes**

Additional Materials: Multiple Choice Answer Sheet  
Soft clean eraser  
Soft pencil (type B or HB is recommended)

\* 1 3 1 5 2 5 3 7 1 0 \*

---

**READ THESE INSTRUCTIONS FIRST**

Write in soft pencil.

Do not use staples, paper clips, glue or correction fluid.

Write your name, Centre number and candidate number on the Answer Sheet in the spaces provided unless this has been done for you.

**DO NOT WRITE IN ANY BARCODES.**

There are **forty** questions on this paper. Answer **all** questions. For each question there are four possible answers **A, B, C** and **D**.

Choose the **one** you consider correct and record your choice in **soft pencil** on the separate Answer Sheet.

**Read the instructions on the Answer Sheet very carefully.**

Each correct answer will score one mark. A mark will not be deducted for a wrong answer.

Any working should be done in this booklet.

Electronic calculators may be used.

---

This document consists of **18** printed pages and **2** blank pages.

2

**Data**

speed of light in free space	$c = 3.00 \times 10^8 \text{ m s}^{-1}$
permeability of free space	$\mu_0 = 4\pi \times 10^{-7} \text{ H m}^{-1}$
permittivity of free space	$\epsilon_0 = 8.85 \times 10^{-12} \text{ F m}^{-1}$ $(\frac{1}{4\pi\epsilon_0} = 8.99 \times 10^9 \text{ m F}^{-1})$
elementary charge	$e = 1.60 \times 10^{-19} \text{ C}$
the Planck constant	$h = 6.63 \times 10^{-34} \text{ J s}$
unified atomic mass unit	$1 \text{ u} = 1.66 \times 10^{-27} \text{ kg}$
rest mass of electron	$m_e = 9.11 \times 10^{-31} \text{ kg}$
rest mass of proton	$m_p = 1.67 \times 10^{-27} \text{ kg}$
molar gas constant	$R = 8.31 \text{ J K}^{-1} \text{ mol}^{-1}$
the Avogadro constant	$N_A = 6.02 \times 10^{23} \text{ mol}^{-1}$
the Boltzmann constant	$k = 1.38 \times 10^{-23} \text{ J K}^{-1}$
gravitational constant	$G = 6.67 \times 10^{-11} \text{ N m}^2 \text{ kg}^{-2}$
acceleration of free fall	$g = 9.81 \text{ m s}^{-2}$

### Formulae

uniformly accelerated motion	$s = ut + \frac{1}{2}at^2$ $v^2 = u^2 + 2as$
work done on/by a gas	$W = p\Delta V$
gravitational potential	$\phi = -\frac{Gm}{r}$
hydrostatic pressure	$p = \rho gh$
pressure of an ideal gas	$p = \frac{1}{3} \frac{Nm}{V} \langle c^2 \rangle$
simple harmonic motion	$a = -\omega^2 x$
velocity of particle in s.h.m.	$v = v_0 \cos \omega t$ $v = \pm \omega \sqrt{(x_0^2 - x^2)}$
Doppler effect	$f_o = \frac{f_s v}{v \pm v_s}$
electric potential	$V = \frac{Q}{4\pi\epsilon_0 r}$
capacitors in series	$1/C = 1/C_1 + 1/C_2 + \dots$
capacitors in parallel	$C = C_1 + C_2 + \dots$
energy of charged capacitor	$W = \frac{1}{2}QV$
electric current	$I = Anvq$
resistors in series	$R = R_1 + R_2 + \dots$
resistors in parallel	$1/R = 1/R_1 + 1/R_2 + \dots$
Hall voltage	$V_H = \frac{BI}{ntq}$
alternating current/voltage	$x = x_0 \sin \omega t$
radioactive decay	$x = x_0 \exp(-\lambda t)$
decay constant	$\lambda = \frac{0.693}{t_{\frac{1}{2}}}$

4

1 What is the approximate average speed of a winning female Olympic athlete running a 100... race?

- A  $6 \text{ ms}^{-1}$       B  $9 \text{ ms}^{-1}$       C  $12 \text{ ms}^{-1}$       D  $15 \text{ ms}^{-1}$

2 Two forces act on a circular disc as shown.

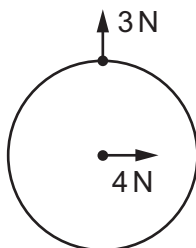

Which diagram shows the line of action of the resultant force?

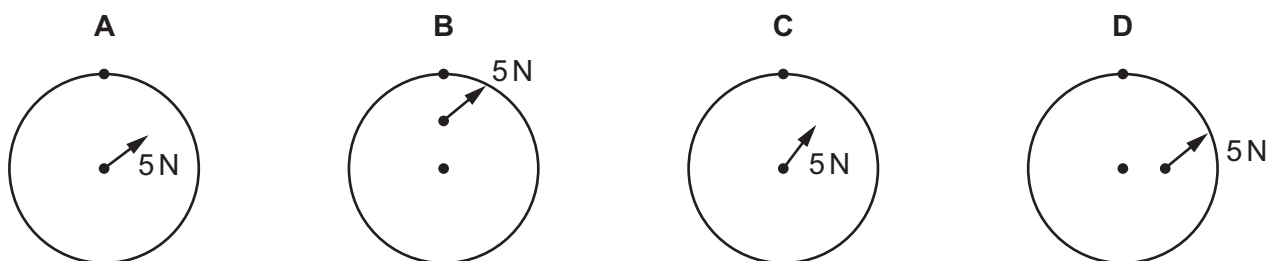

3 What correctly expresses the volt in terms of SI base units?

- A  $A\Omega$   
 B  $WA^{-1}$   
 C  $\text{kg m}^2 \text{s}^{-1} \text{A}^{-1}$   
 D  $\text{kg m}^2 \text{s}^{-3} \text{A}^{-1}$

- 4 The current in a block of semiconductor is 30.0 mA when there is a potential difference (p.d.) of 10.0 V across it. The dimensions of the block and the direction of the current in it are as shown.

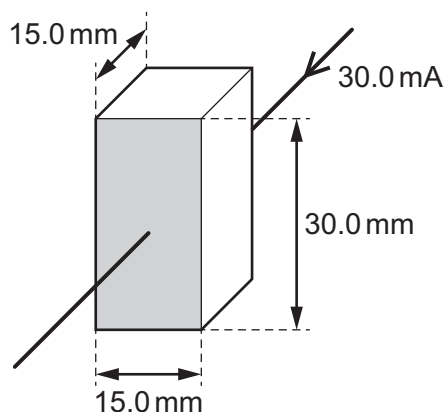

The electrical meters used are accurate to  $\pm 0.1$  mA and  $\pm 0.1$  V. The dimensions of the block are accurate to  $\pm 0.2$  mm.

What is the resistivity of the semiconductor?

- A  $10.0 \pm 0.2 \Omega \text{ m}$   
 B  $10.0 \pm 0.3 \Omega \text{ m}$   
 C  $10.0 \pm 0.5 \Omega \text{ m}$   
 D  $10.0 \pm 0.8 \Omega \text{ m}$
- 5 The diameter of a cylindrical metal rod is measured using a micrometer screw gauge.

The diagram below shows an enlargement of the scale on the micrometer screw gauge when taking the measurement.

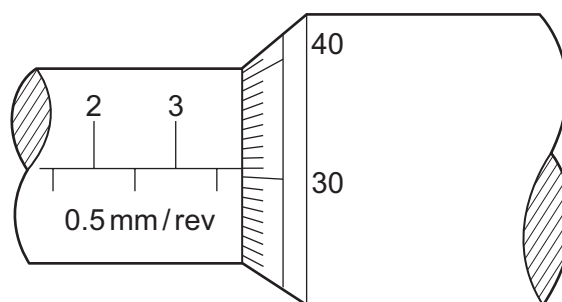

What is the cross-sectional area of the rod?

- A  $3.81 \text{ mm}^2$       B  $11.4 \text{ mm}^2$       C  $22.8 \text{ mm}^2$       D  $45.6 \text{ mm}^2$

- 6 A ball is set in motion at P on a frictionless surface. It moves up slope PQ, along the horizontal surface QR and finally descends slope RS.

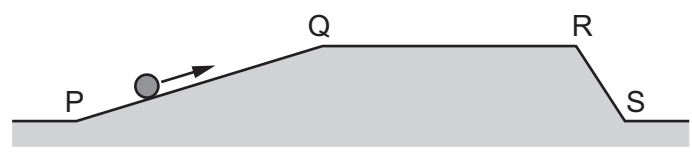

Which graph could represent the variation with time  $t$  of the ball's speed  $v$  as the ball moves from P to S?

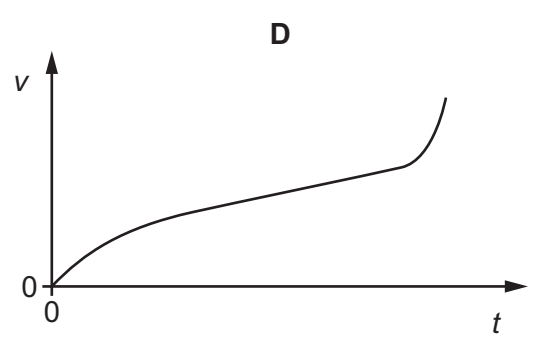
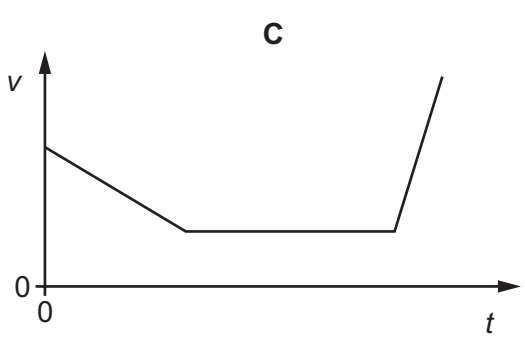
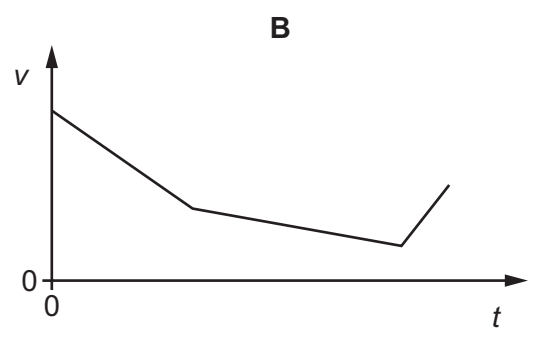
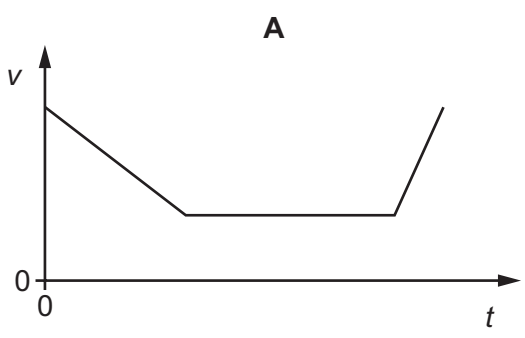

- 7 A rubber ball is dropped onto a table and bounces back up. The table exerts a force  $F$  on the ball.

Which graph best shows the variation with time  $t$  of the force  $F$  for the short time that the ball is in contact with the table?

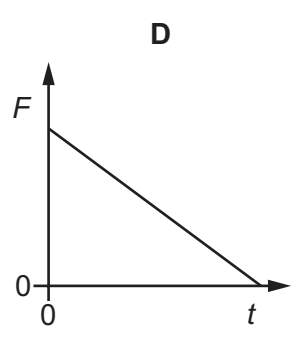
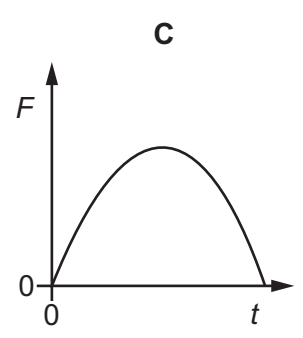
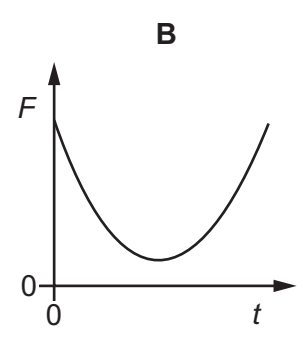
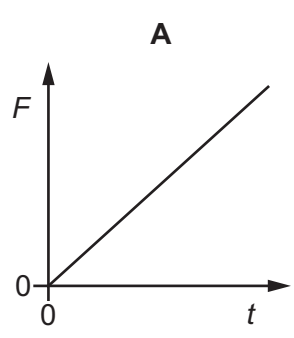

- 8 A golf ball of mass  $m$  is dropped onto a hard surface from a height  $h_1$  and rebounds to a height  $h_2$ .

The momentum of the golf ball just as it reaches the surface is different from its momentum just as it leaves the surface.

What is the total change in the momentum of the golf ball between these two instants? (Ignore air resistance.)

- A  $m\sqrt{2gh_1} - m\sqrt{2gh_2}$
- B  $m\sqrt{2gh_1} + m\sqrt{2gh_2}$
- C  $m\sqrt{2g(h_1 - h_2)}$
- D  $m\sqrt{2g(h_1 + h_2)}$
- 9 A book of weight  $W$  is at rest on a table. A student attempts to state Newton's third law of motion by saying that 'action equals reaction'.

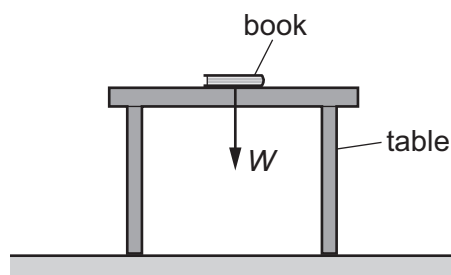

If the weight of the book is the 'action' force, what is the 'reaction' force?

- A the force  $W$  acting downwards on the Earth from the table
- B the force  $W$  acting upwards on the book from the table
- C the force  $W$  acting upwards on the Earth from the book
- D the force  $W$  acting upwards on the table from the floor

- 10 A metal cylinder is suspended vertically in equilibrium by a cord. The diagram shows the cylinder in four different positions P, Q, R and S.

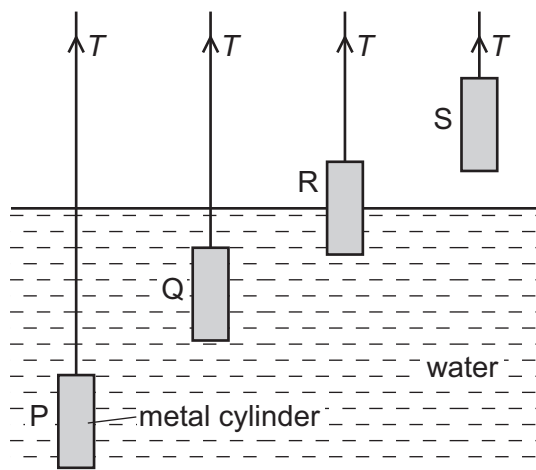

Which statement explains the variation of the tension  $T$  in the cord?

- A At P and at Q, the tension  $T$  in the cord is the same because the difference in pressure between the top and bottom of the cylinder is the same.
- B At Q, the tension  $T$  in the cord is less than at P because, at smaller depth, liquid pressure is smaller.
- C At R, the tension  $T$  in the cord is less than at P because atmospheric pressure is less than water pressure.
- D At S, the tension  $T$  in the cord is greater than at P because atmospheric pressure at S exerts no force on the top or bottom of the cylinder.



11 In a machine, many couples act on a rotating object as shown.

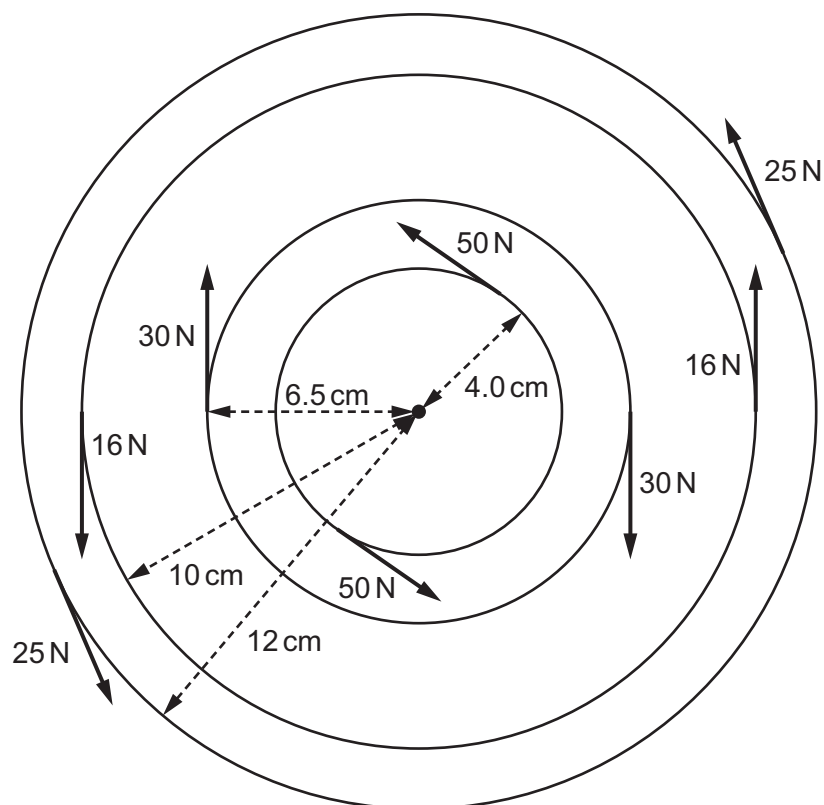

What is the resultant torque acting on the rotating object?

- A 4.7 Nm      B 8.6 Nm      C 9.3 Nm      D 17.1 Nm

12 A uniform beam is pivoted at P as shown. Weights of 10 N and 20 N are attached to its ends.

The length of the beam is marked at 0.1 m intervals. The weight of the beam is 100 N.

At which point should a further weight of 20 N be attached to achieve equilibrium?

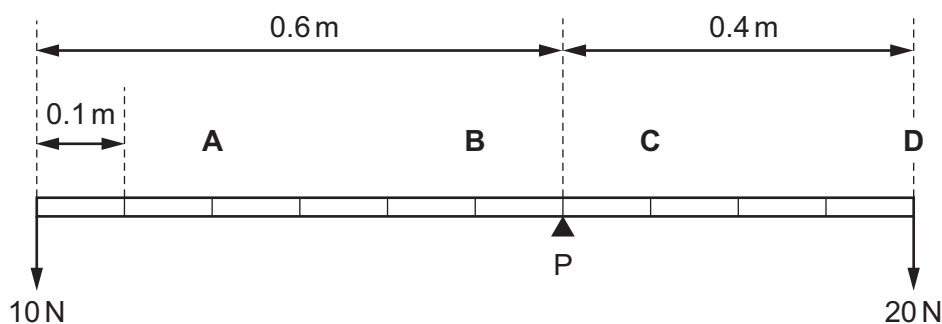

13 What are the SI base units of the quantity  $\frac{\text{pressure}}{\text{density}}$  ?

- A  $\text{s}^{-2}$       B  $\text{kg}^2\text{s}^{-2}$       C  $\text{kg}^2\text{m}^2\text{s}^{-2}$       D  $\text{m}^2\text{s}^{-2}$

14 Which quantities are conserved in an inelastic collision?

	kinetic energy	total energy	linear momentum
<b>A</b>	conserved	not conserved	conserved
<b>B</b>	conserved	not conserved	not conserved
<b>C</b>	not conserved	conserved	conserved
<b>D</b>	not conserved	conserved	not conserved

15 A cyclist is travelling at a constant speed up a hill. The frictional force resisting the cyclist's motion is 8.0 N.

The cyclist uses 450 J of energy to travel a distance of 20 m.

What is the increase in the gravitational potential energy of the cyclist?

- A** 160 J      **B** 290 J      **C** 440 J      **D** 610 J

16 A stone of mass  $m$  falls from rest at the top of a cliff of height  $h$  into the sea below. Just before hitting the sea the stone has speed  $v$ .

What is the average force of air resistance acting on the stone during its fall?

- A**  $mg$       **B**  $\frac{m(v^2 - 2gh)}{h}$       **C**  $m\left(g - \frac{v^2}{2h}\right)$       **D**  $m\left(gh - \frac{v^2}{2}\right)$

17 A railway engine accelerates a train of total mass 1200 tonnes (1 tonne = 1000 kg) from rest to a speed of  $75 \text{ m s}^{-1}$ .

How much useful work must be done on the train to reach this speed?

- A**  $3.4 \times 10^6 \text{ J}$       **B**  $6.8 \times 10^6 \text{ J}$       **C**  $3.4 \times 10^9 \text{ J}$       **D**  $6.8 \times 10^9 \text{ J}$

18 What is a correct derivation of the equation relating power, force and velocity?

**A** power =  $\frac{\text{work done}}{\text{time taken}}$  and work done = force  $\times$  displacement

so power =  $\frac{\text{force} \times \text{displacement}}{\text{time taken}}$

so power = force  $\times$  velocity

**B** power =  $\frac{\text{work done}}{\text{time taken}}$  and work done = force  $\times$  distance

so power =  $\frac{\text{force} \times \text{distance}}{\text{time taken}}$

so power = force  $\times$  velocity

**C** power =  $\frac{\text{work done}}{\text{time taken}}$  and work done =  $\frac{\text{force}}{\text{displacement}}$

so power =  $\frac{\text{force}}{\text{displacement}} \times \text{time taken}$

so power =  $\frac{\text{force}}{\text{velocity}}$

**D** power =  $\frac{\text{work done}}{\text{time taken}}$  and work done =  $\frac{\text{force}}{\text{distance}}$

so power =  $\frac{\text{force}}{\text{distance}} \times \text{time taken}$

so power =  $\frac{\text{force}}{\text{velocity}}$

19 A cable on a suspension bridge supports a weight of  $19.3 \times 10^5 \text{ N}$ . This weight causes the cable to stretch by 47 mm.

A lorry crossing the bridge then increases the force on the cable to  $23.3 \times 10^5 \text{ N}$ . The force-extension graph for the cable is shown.

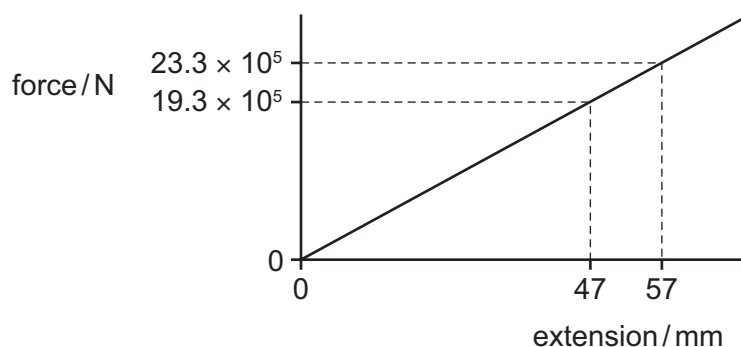

What is the **increase** in strain energy in the cable when the lorry is crossing the bridge?

- A** 21 kJ      **B** 23 kJ      **C** 45 kJ      **D** 66 kJ

20 What are the units of stress, strain and the Young modulus?

	stress	strain	Young modulus
<b>A</b>	newton	metre	pascal
<b>B</b>	newton	no unit	newton
<b>C</b>	pascal	metre	newton
<b>D</b>	pascal	no unit	pascal

21 A rubber band is stretched and then relaxed to its original length. The diagram shows the force-extension graph for this process.

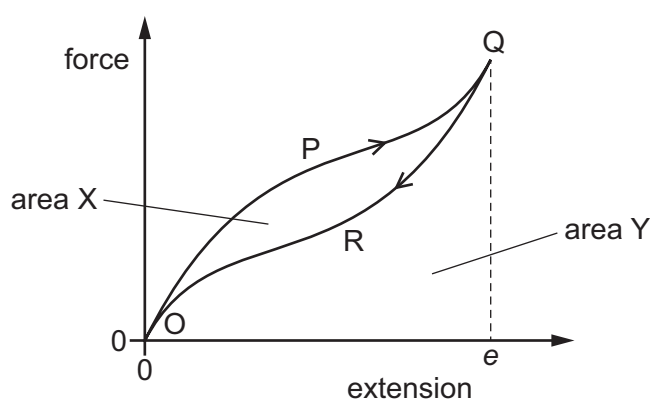

As the force is increased, the curve follows the path OPQ to extension  $e$ . As the force is reduced, the curve follows the path QRO to return to zero extension.

The area labelled X is between the curves OPQ and QRO. The area labelled Y is bounded by the curve QRO and the horizontal axis.

Which statement about the process is correct?

- A** Area X is the energy which heats the band as it is stretched to extension  $e$ .
- B** (Area X + area Y) is the minimum energy required to stretch the band to extension  $e$ .
- C** Area X is the elastic potential energy stored in the band when it is stretched to extension  $e$ .
- D** (Area Y – area X) is the net work done on the band during the process.

22 The period of an electromagnetic wave is 1.0 ns.

What are the frequency and wavelength of the wave?

	frequency / Hz	wavelength / m
<b>A</b>	1.0	$3.0 \times 10^8$
<b>B</b>	$1.0 \times 10^6$	300
<b>C</b>	$1.0 \times 10^9$	0.30
<b>D</b>	$1.0 \times 10^{12}$	$3.0 \times 10^{-4}$

23 Which statement about progressive longitudinal waves is **not** correct?

- A** The oscillations of the particles are parallel to the direction of travel of the wave energy.
- B** They have a series of nodes and antinodes.
- C** They need a medium through which to travel.
- D** They transfer energy.

24 A bicycle gear wheel is a disc with 50 'teeth' equally spaced around its edge, as shown. The gear wheel is rotated 10 times each second. A springy strip of metal is vibrated by the rotating 'teeth'. The metal strip produces a sound of frequency that is equal to the frequency of vibration of the strip.

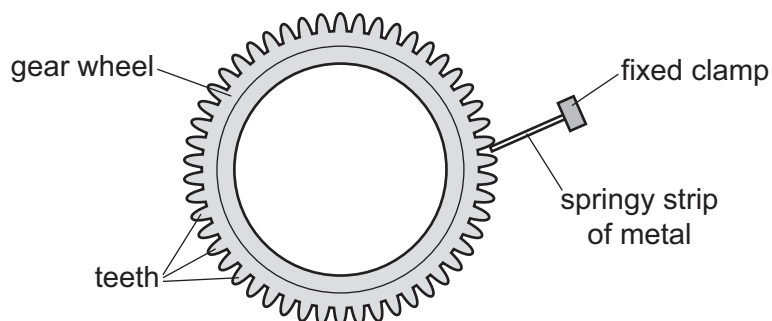

The speed of sound in air is  $330 \text{ m s}^{-1}$ .

What is the wavelength of the emitted sound?

- A** 0.66 m
- B** 1.5 m
- C** 6.6 m
- D** 500 m

- 25 An ambulance travels along a straight road at a speed of  $30.0 \text{ m s}^{-1}$ . Its siren emits sound of frequency  $2000 \text{ Hz}$ . The speed of sound in the air is  $340 \text{ m s}^{-1}$ . The ambulance passes a man standing at the side of the road.

What is the frequency of the sound heard by the man as the ambulance moves towards him and as the ambulance moves away from him?

	frequency heard as ambulance moves towards man / Hz	frequency heard as ambulance moves away from man / Hz
<b>A</b>	1820	2180
<b>B</b>	1840	2190
<b>C</b>	2180	1820
<b>D</b>	2190	1840

- 26 Three different electromagnetic waves P, Q and R have the frequencies shown.

	frequency / Hz
P	$3 \times 10^{10}$
Q	$3 \times 10^{13}$
R	$6 \times 10^{14}$

Which row identifies P, Q and R?

	P	Q	R
<b>A</b>	infra-red	visible	ultraviolet
<b>B</b>	microwave	infra-red	visible
<b>C</b>	ultraviolet	X-ray	gamma ray
<b>D</b>	visible	ultraviolet	X-ray

- 27 Which row describes the oscillations of two moving particles in a stationary wave that are separated by a distance of half a wavelength?

	phase difference	amplitude
<b>A</b>	$90^\circ$	different
<b>B</b>	$90^\circ$	same
<b>C</b>	$180^\circ$	different
<b>D</b>	$180^\circ$	same

- 28 A parallel beam of red light of wavelength 700 nm is incident normally on a diffraction grating that has 400 lines per millimetre.

What is the total number of intensity maxima from the grating?

- A 6                      B 7                      C 8                      D 9

- 29 Two wave sources are oscillating in phase. Each source produces a wave of wavelength  $\lambda$ . The two waves from the sources meet at point X with a phase difference of  $90^\circ$ .

What is a possible difference in the distances from the two wave sources to point X?

- A  $\frac{\lambda}{8}$                       B  $\frac{\lambda}{4}$                       C  $\frac{\lambda}{2}$                       D  $\lambda$

- 30 Which diagram best illustrates the electric field around a positive point charge?

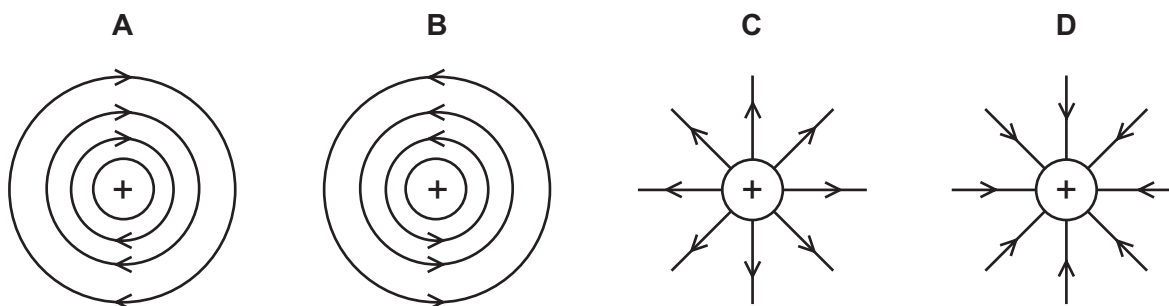

- 31 The path of an electron with initial speed  $v$  in the uniform electric field between two parallel plates is shown.

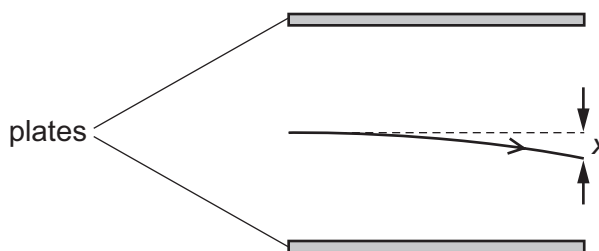

The vertical deflection  $x$  is measured at the right-hand edge of the plates.

The distance between the plates is halved. The potential difference between the plates remains the same.

What will be the new deflection of the electron with the same initial speed  $v$ ?

- A  $x$                       B  $\sqrt{2}x$                       C  $2x$                       D  $4x$

- 32 The current in a circuit component is  $2.00\ \mu\text{A}$ .

How many electrons pass through the component each second?

- A**  $1.25 \times 10^{13}$     **B**  $1.25 \times 10^{16}$     **C**  $1.25 \times 10^{19}$     **D**  $1.25 \times 10^{25}$
- 33 The filament of a 240 V, 100 W electric lamp heats up from room temperature to its operating temperature. As it heats up, its resistance increases by a factor of 16.

What is the resistance of the filament at room temperature?

- A**  $36\ \Omega$             **B**  $580\ \Omega$             **C**  $1.5\ \text{k}\Omega$             **D**  $9.2\ \text{k}\Omega$

- 34 Two wires have the same length and the same resistance. Wire X is made of a metal of resistivity  $1.7 \times 10^{-8}\ \Omega\text{m}$  and wire Y is made of a metal of resistivity  $5.6 \times 10^{-8}\ \Omega\text{m}$ .

The diameter of wire X is 0.315 mm.

What is the diameter of wire Y?

- A** 0.17 mm            **B** 0.33 mm            **C** 0.57 mm            **D** 1.0 mm

- 35 A cell has a constant electromotive force.

A variable resistor is connected between the terminals of the cell.

The resistance of the variable resistor is decreased.

Which statement about the change of the cell's terminal potential difference (p.d.) is correct?

- A** The terminal p.d. is decreased because more work is done moving unit charge through the internal resistance of the cell.
- B** The terminal p.d. is decreased because the current in the variable resistor is decreased.
- C** The terminal p.d. is increased because more work is done moving unit charge through the variable resistor.
- D** The terminal p.d. is increased because the current in the variable resistor is increased.



36 Four resistors are connected in a square as shown.

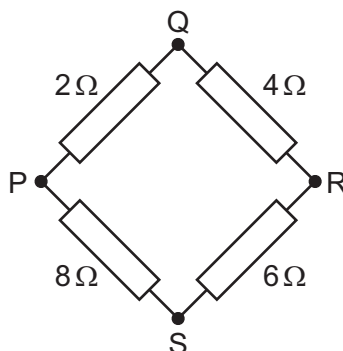

The resistance may be measured between any two junctions.

Between which two junctions is the measured resistance greatest?

- A** P and Q      **B** Q and S      **C** R and S      **D** S and P

37 A circuit is set up as shown.

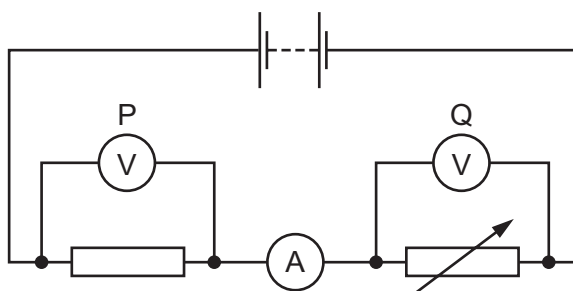

The variable resistor is adjusted so that the ammeter reading decreases.

How do the readings of the voltmeters change?

	reading on voltmeter P	reading on voltmeter Q
<b>A</b>	decreases	decreases
<b>B</b>	decreases	increases
<b>C</b>	increases	decreases
<b>D</b>	increases	increases

- 38** In a television programme to illustrate scientific models, a presenter fires a gun many times at a bale of hay. Two small cannon balls are embedded within the hay some distance apart from each other.

The hay bale measures approximately  $2\text{ m} \times 2\text{ m} \times 2\text{ m}$  and the cannon balls are made of iron, approximately spherical, and about 5 cm in diameter.

What might the presenter be illustrating?

- A**  $\alpha$ -particle scattering
  - B**  $\beta^-$  decay
  - C** conservation of momentum
  - D** double-slit interference
- 39** A certain nuclide, uranium-235, has nucleon number 235, proton number 92 and neutron number 143. Data on four other nuclides are given below.

Which nuclide is an isotope of uranium-235?

	nucleon number	proton number	neutron number
<b>A</b>	235	91	144
<b>B</b>	236	92	144
<b>C</b>	237	94	143
<b>D</b>	238	95	143

- 40** During  $\beta^-$  decay, which change takes place to the quark composition of the nucleus that emits the  $\beta^-$  particle, and which other particle is emitted?

	quark change	other particle emitted
<b>A</b>	down to up	antineutrino
<b>B</b>	down to up	neutrino
<b>C</b>	up to down	antineutrino
<b>D</b>	up to down	neutrino

**BLANK PAGE**

**BLANK PAGE**

---

Permission to reproduce items where third-party owned material protected by copyright is included has been sought and cleared where possible. Every reasonable effort has been made by the publisher (UCLES) to trace copyright holders, but if any items requiring clearance have unwittingly been included, the publisher will be pleased to make amends at the earliest possible opportunity.

To avoid the issue of disclosure of answer-related information to candidates, all copyright acknowledgements are reproduced online in the Cambridge International Examinations Copyright Acknowledgements Booklet. This is produced for each series of examinations and is freely available to download at [www.cie.org.uk](http://www.cie.org.uk) after the live examination series.

Cambridge International Examinations is part of the Cambridge Assessment Group. Cambridge Assessment is the brand name of University of Cambridge Local Examinations Syndicate (UCLES), which is itself a department of the University of Cambridge.