

Cambridge
International
AS & A Level**Cambridge International Examinations**
Cambridge International Advanced Subsidiary and Advanced Level**PHYSICS****9702/13**

Paper 1 Multiple Choice

May/June 2015**1 hour**

Additional Materials: Multiple Choice Answer Sheet
 Soft clean eraser
 Soft pencil (type B or HB is recommended)

* 6 0 2 5 5 1 9 1 1 0 *

**READ THESE INSTRUCTIONS FIRST**

Write in soft pencil.

Do not use staples, paper clips, glue or correction fluid.

Write your name, Centre number and candidate number on the Answer Sheet in the spaces provided unless this has been done for you.

DO NOT WRITE IN ANY BARCODES.There are **forty** questions on this paper. Answer **all** questions. For each question there are four possible answers **A, B, C** and **D**.Choose the **one** you consider correct and record your choice in **soft pencil** on the separate Answer Sheet.**Read the instructions on the Answer Sheet very carefully.**

Each correct answer will score one mark. A mark will not be deducted for a wrong answer.

Any working should be done in this booklet.

Electronic calculators may be used.

This document consists of **19** printed pages and **1** blank page.

2

Data

speed of light in free space,	$c = 3.00 \times 10^8 \text{ m s}^{-1}$
permeability of free space,	$\mu_0 = 4\pi \times 10^{-7} \text{ H m}^{-1}$
permittivity of free space,	$\epsilon_0 = 8.85 \times 10^{-12} \text{ F m}^{-1}$
	$\left(\frac{1}{4\pi\epsilon_0}\right) = 8.99 \times 10^9 \text{ m F}^{-1}$
elementary charge,	$e = 1.60 \times 10^{-19} \text{ C}$
the Planck constant,	$h = 6.63 \times 10^{-34} \text{ J s}$
unified atomic mass constant,	$u = 1.66 \times 10^{-27} \text{ kg}$
rest mass of electron,	$m_e = 9.11 \times 10^{-31} \text{ kg}$
rest mass of proton,	$m_p = 1.67 \times 10^{-27} \text{ kg}$
molar gas constant,	$R = 8.31 \text{ J K}^{-1} \text{ mol}^{-1}$
the Avogadro constant,	$N_A = 6.02 \times 10^{23} \text{ mol}^{-1}$
the Boltzmann constant,	$k = 1.38 \times 10^{-23} \text{ J K}^{-1}$
gravitational constant,	$G = 6.67 \times 10^{-11} \text{ N m}^2 \text{ kg}^{-2}$
acceleration of free fall,	$g = 9.81 \text{ m s}^{-2}$

Formulae

uniformly accelerated motion,	$s = ut + \frac{1}{2}at^2$ $v^2 = u^2 + 2as$
work done on/by a gas,	$W = p\Delta V$
gravitational potential,	$\phi = -\frac{Gm}{r}$
hydrostatic pressure,	$p = \rho gh$
pressure of an ideal gas,	$p = \frac{1}{3} \frac{Nm}{V} \langle c^2 \rangle$
simple harmonic motion,	$a = -\omega^2 x$
velocity of particle in s.h.m.,	$v = v_0 \cos \omega t$ $v = \pm \omega \sqrt{(x_0^2 - x^2)}$
electric potential,	$V = \frac{Q}{4\pi\epsilon_0 r}$
capacitors in series,	$1/C = 1/C_1 + 1/C_2 + \dots$
capacitors in parallel,	$C = C_1 + C_2 + \dots$
energy of charged capacitor,	$W = \frac{1}{2}QV$
resistors in series,	$R = R_1 + R_2 + \dots$
resistors in parallel,	$1/R = 1/R_1 + 1/R_2 + \dots$
alternating current/voltage,	$x = x_0 \sin \omega t$
radioactive decay,	$x = x_0 \exp(-\lambda t)$
decay constant,	$\lambda = \frac{0.693}{t_{\frac{1}{2}}}$

1 Which statement includes a correct unit?

- A energy = 7.8 N s
- B force = 3.8 N s
- C momentum = 6.2 N s
- D torque = 4.7 N s

2 What is the joule (J) in SI base units?

- A kg m s^{-1}
- B $\text{kg m}^2 \text{s}^{-1}$
- C kg m s^{-2}
- D $\text{kg m}^2 \text{s}^{-2}$

3 The speed of an aeroplane in still air is 200 km h^{-1} . The wind blows from the west at a speed of 85.0 km h^{-1} .

In which direction must the pilot steer the aeroplane in order to fly due north?

- A 23.0° east of north
- B 23.0° west of north
- C 25.2° east of north
- D 25.2° west of north

4 A student is given a reel of wire of diameter less than 0.2 mm and is asked to find the density of the metal.

Which pair of instruments would be most suitable for finding the **volume** of the wire?

- A balance and micrometer
- B metre rule and micrometer
- C metre rule and vernier calipers
- D micrometer and vernier calipers

- 5 Four different students use a ruler to measure the length of a 15.0 cm pencil. Their measurements are recorded on four different charts.

Which chart shows measurements that are precise but **not** accurate?

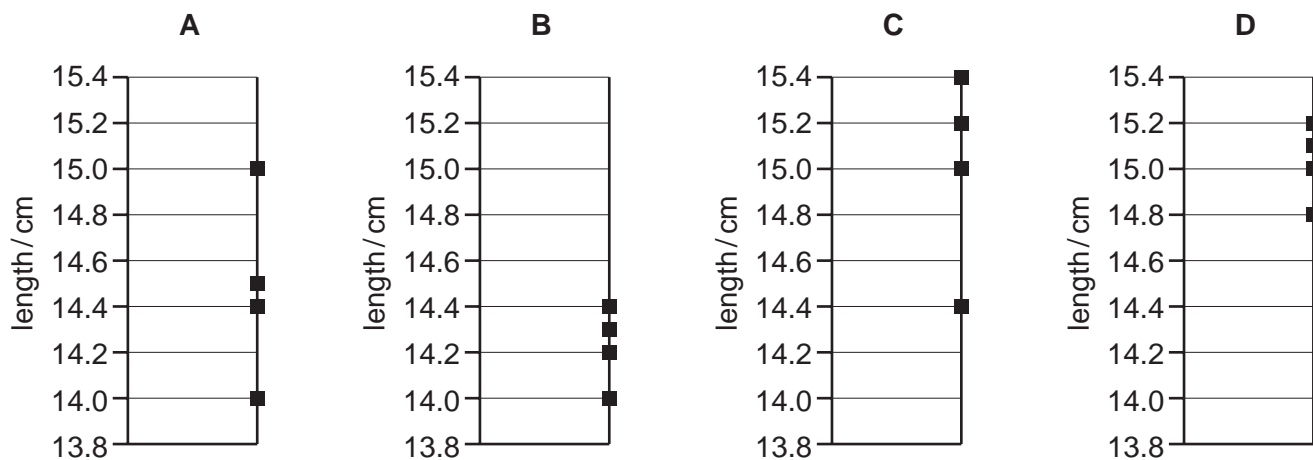

- 6 In a simple electrical circuit, the current in a resistor is measured as (2.50 ± 0.05) mA. The resistor is marked as having a value of $4.7 \Omega \pm 2\%$.

If these values were used to calculate the power dissipated in the resistor, what would be the percentage uncertainty in the value obtained?

- A 2% B 4% C 6% D 8%
- 7 A raindrop falls vertically from rest in air. The variation with time of the speed of the raindrop is shown in the graph.

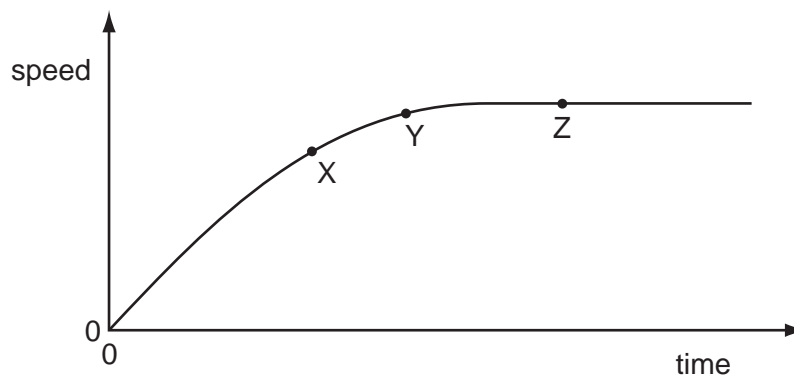

Which statement about the raindrop is correct?

- A At point X, the raindrop has an acceleration of 9.81 m s^{-2} .
- B At point Z, the force on the raindrop due to air resistance has reached its maximum value and so the acceleration of the raindrop has also reached its maximum value.
- C At point Z, the force due to air resistance is equal and opposite to the weight of the raindrop and so the speed of the raindrop is zero.
- D The resultant force on the raindrop at point Y is less than the resultant force on the raindrop at point X.

- 8 The velocity of an electric car changes as shown.

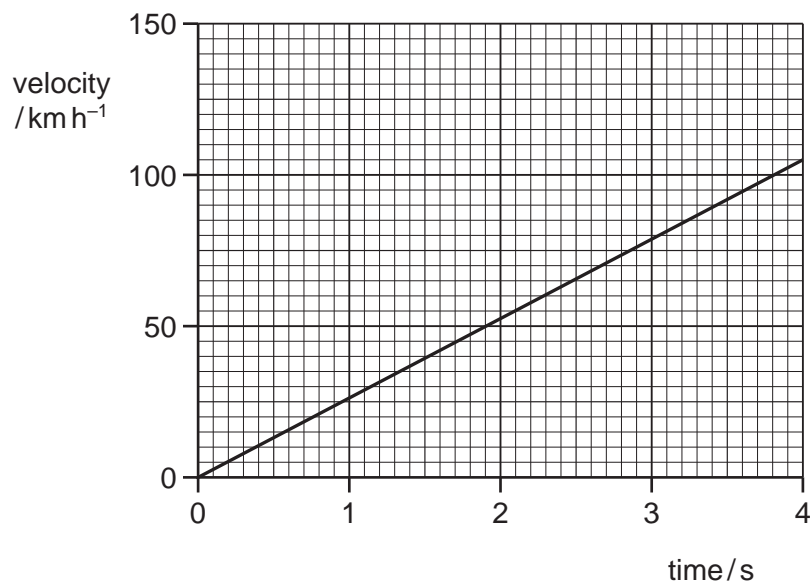

What is the acceleration of the car?

- A** 210 ms^{-2} **B** 58 ms^{-2} **C** 26 ms^{-2} **D** 7.3 ms^{-2}
- 9 A body falling in a uniform gravitational field encounters air resistance. The air resistance increases until terminal velocity is reached.
- Which factor does **not** affect its terminal velocity?
- A** the density of the air
B the height from which the body falls
C the mass of the body
D the shape of the body
- 10 Which of the following is a statement of the principle of conservation of momentum?
- A** Momentum is the product of mass and velocity.
B In an elastic collision, momentum is constant.
C The momentum of an isolated system is constant.
D The force acting on a body is proportional to its rate of change of momentum.

- 11 A moving object strikes a stationary object. The collision is inelastic. The objects move together.

Which row shows the possible values of total momentum and total kinetic energy for the system before and after the collision?

	total momentum before collision / kg m s ⁻¹	total momentum after collision / kg m s ⁻¹	total kinetic energy before collision / J	total kinetic energy after collision / J
A	6	2	90	30
B	6	6	30	90
C	6	6	90	30
D	6	6	90	90

- 12 Two balls X and Y are moving towards each other with speeds of 5 ms⁻¹ and 15 ms⁻¹ respectively.

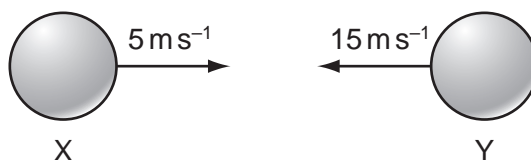

They make a perfectly elastic head-on collision and ball Y moves to the right with a speed of 7 ms⁻¹.

What is the speed and direction of ball X after the collision?

- A** 3 ms⁻¹ to the left
- B** 13 ms⁻¹ to the left
- C** 3 ms⁻¹ to the right
- D** 13 ms⁻¹ to the right

- 13 A wooden block is freely supported on brackets at a height of 4.0 m above the ground, as shown.

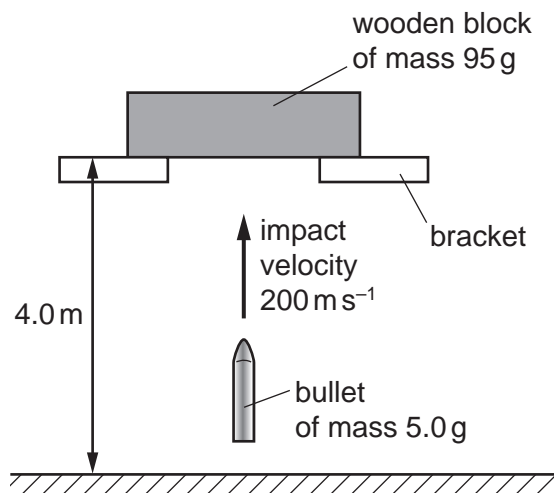

A bullet of mass 5.0 g is shot vertically upwards into the wooden block of mass 95 g. It embeds itself in the block. The impact causes the block to rise above its supporting brackets.

The bullet hits the block with a velocity of 200 m s⁻¹. How far above the ground will the block be at the maximum height of its path?

- A 5.1 m B 5.6 m C 9.1 m D 9.6 m
- 14 Four cuboids with identical length, breadth and height are immersed in water. The cuboids are held at the same depth and in identical orientations by vertical rods, as shown.

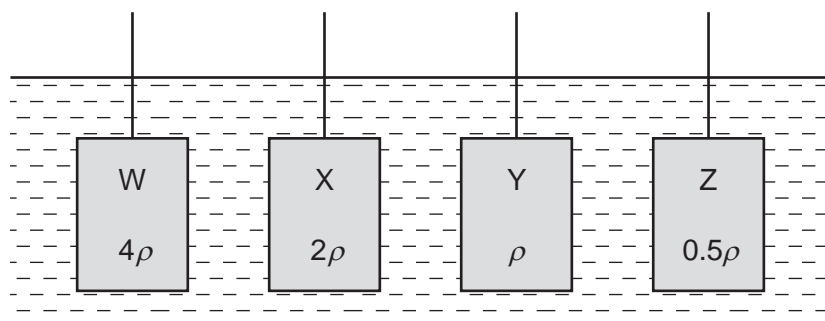

Water has density ρ .

Cuboid W is made of material of density 4ρ .

Cuboid X is made of material of density 2ρ .

Cuboid Y is made of material of density ρ .

Cuboid Z is made of material of density 0.5ρ .

Which statement is correct?

- A The upthrust of the water on each of the cuboids is the same.
- B The upthrust of the water on W is twice the upthrust of the water on X.
- C The upthrust of the water on X is twice the upthrust of the water on W.
- D The upthrust of the water on Y is zero.

- 15** An air bubble in a tank of water is rising with constant velocity. The forces acting on the bubble are X , Y and Z as shown.

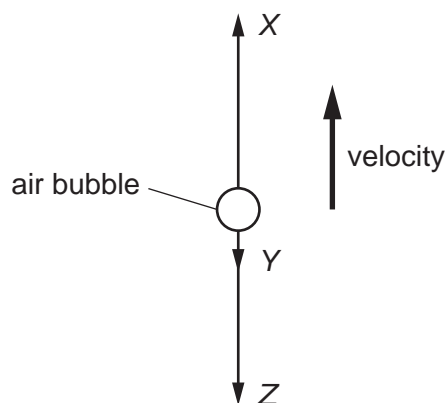

What describes the three forces?

- A** Z is the viscous drag on the bubble, Y is the weight of the bubble, X is the upthrust on the bubble and $X = Y + Z$.
- B** Z is the viscous drag on the bubble, Y is the weight of the bubble, X is the upthrust on the bubble and $X > Y + Z$.
- C** Z is the weight of the bubble, Y is the viscous drag on the bubble, X is the upthrust on the bubble and $X = Y + Z$.
- D** Z is the weight of the bubble, Y is the viscous drag on the bubble, X is the upthrust on the bubble and $X > Y + Z$.
- 16** The diagrams represent systems of coplanar forces acting at a point. The lengths of the force vectors represent the magnitudes of the forces.

Which system of forces is in equilibrium?

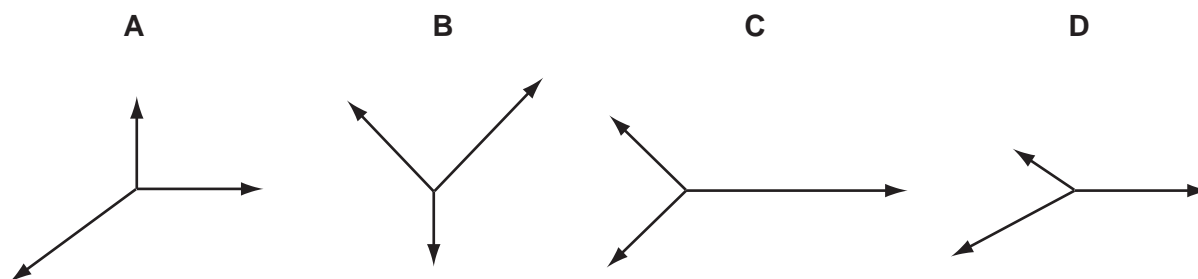

- 17 The gas in an engine does work on a piston of cross-sectional area 80 cm^2 . The pressure on the piston has a constant value of $4.6 \times 10^5 \text{ Pa}$.

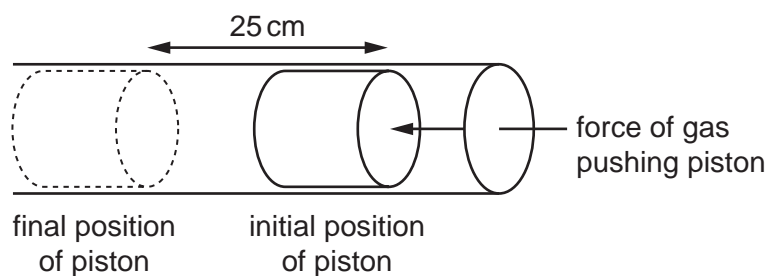

How much work is done by the gas on the piston when it moves through a distance of 25 cm?

- A $9.2 \times 10^2 \text{ J}$ B $9.2 \times 10^4 \text{ J}$ C $9.2 \times 10^6 \text{ J}$ D $9.2 \times 10^8 \text{ J}$
- 18 A loaded aeroplane has a total mass of $1.2 \times 10^5 \text{ kg}$ while climbing after take-off. It climbs at an angle of 23° to the horizontal with a speed of 50 ms^{-1} . What is the rate at which it is gaining potential energy at this time?
- A $2.3 \times 10^6 \text{ Js}^{-1}$
 B $2.5 \times 10^6 \text{ Js}^{-1}$
 C $2.3 \times 10^7 \text{ Js}^{-1}$
 D $2.5 \times 10^7 \text{ Js}^{-1}$
- 19 When a horizontal force F is applied to a frictionless trolley over a distance s , the kinetic energy of the trolley changes from 4.0 J to 8.0 J .
- If a force of $2F$ is applied to the trolley over a distance of $2s$, what will the original kinetic energy of 4.0 J become?
- A 16 J B 20 J C 32 J D 64 J
- 20 When ice melts, it contracts.

Which row is correct for ice turning into water?

	distance between molecules	density
A	decreases	decreases
B	decreases	increases
C	increases	decreases
D	increases	increases

- 21 A W-shaped tube contains two amounts of mercury, each open to the atmosphere. Air at pressure P is trapped in between them. The diagram shows two vertical distances x and y .

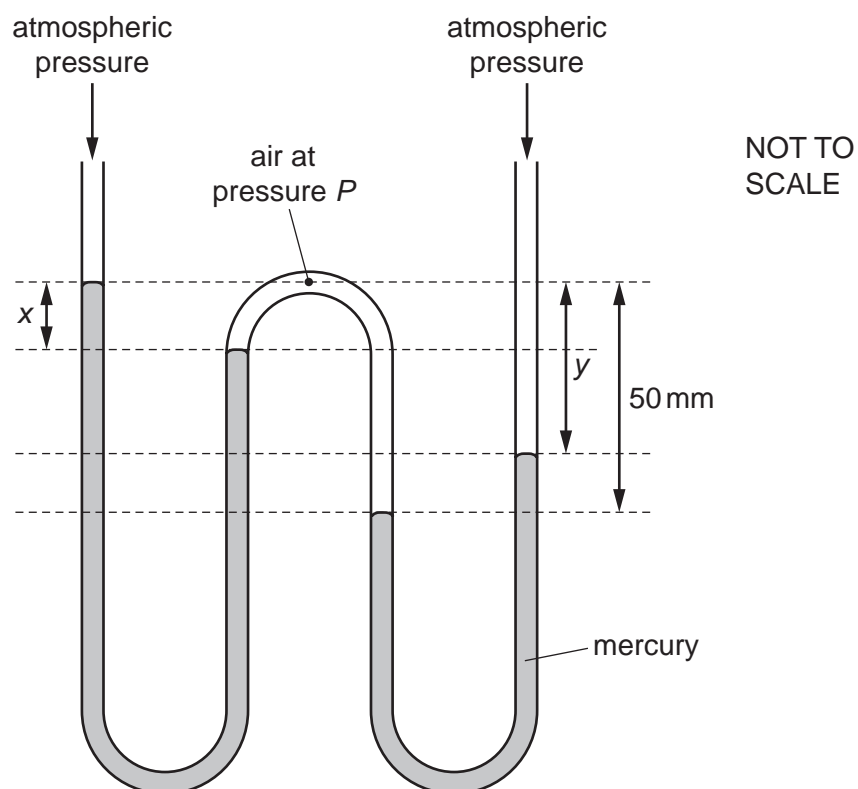

Atmospheric pressure is equal to the pressure that would be exerted by a column of mercury of height 760 mm. The pressure P is expressed in this way.

Which values of x , y and P are possible?

	x/mm	y/mm	$P/\text{mm of mercury}$
A	20	20	780
B	20	30	780
C	30	20	810
D	30	30	790

- 22 A steel bar of circular cross-section is under tension T , as shown.

The diameter of the wide portion is double the diameter of the narrow portion.

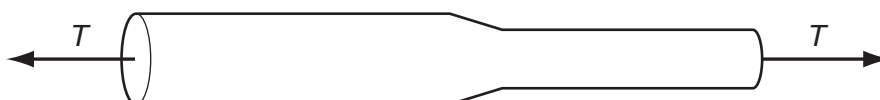

What is the value of $\frac{\text{stress in the wide portion}}{\text{stress in the narrow portion}}$?

- A** 0.25 **B** 0.50 **C** 2.0 **D** 4.0

- 23 The graph shows the non-linear force-extension curve for a wire made from a new composite material.

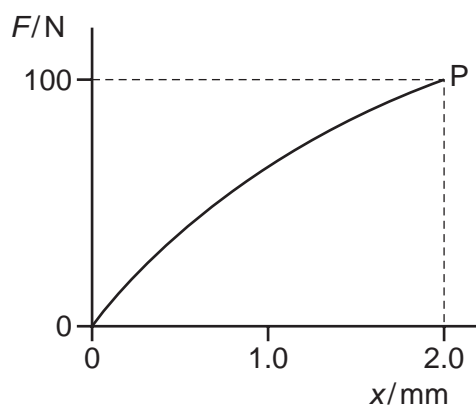

What could be the value of the strain energy stored in the wire when it is stretched elastically to point P?

- A 0.09 J B 0.10 J C 0.11 J D 0.20 J
- 24 The diagram shows the stress-strain graph for bone.

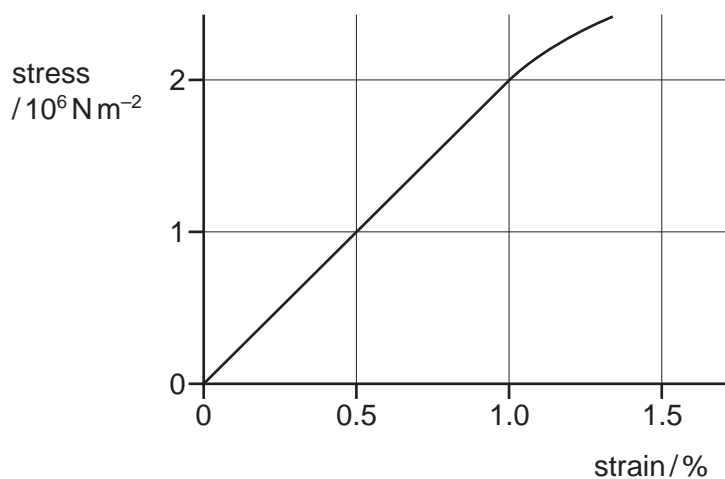

What is the Young modulus of bone?

- A $1 \times 10^6 \text{ Nm}^{-2}$
 B $2 \times 10^6 \text{ Nm}^{-2}$
 C $1 \times 10^8 \text{ Nm}^{-2}$
 D $2 \times 10^8 \text{ Nm}^{-2}$

- 25 A cathode-ray oscilloscope (c.r.o.) is used to display the trace from a sound wave. The time-base is set at $5 \mu\text{s mm}^{-1}$.

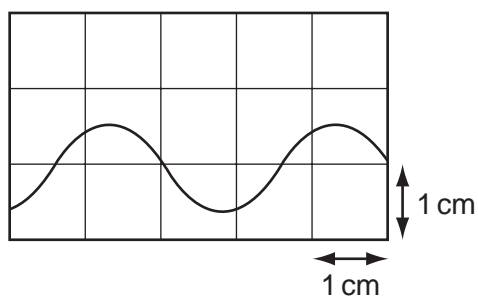

What is the frequency of the sound wave?

- A 6.7 Hz B 67 Hz C 6.7 kHz D 67 kHz
- 26 A wave pulse moves along a stretched rope in the direction shown.

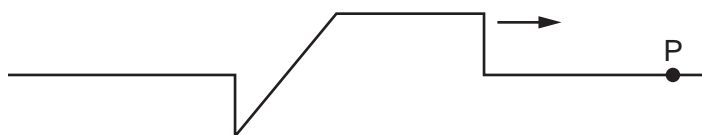

Which diagram correctly shows the variation with time t of the displacement s of the particle P in the rope?

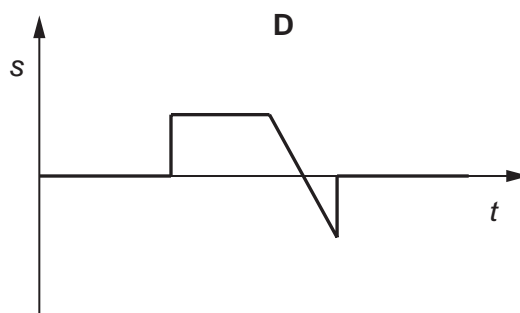
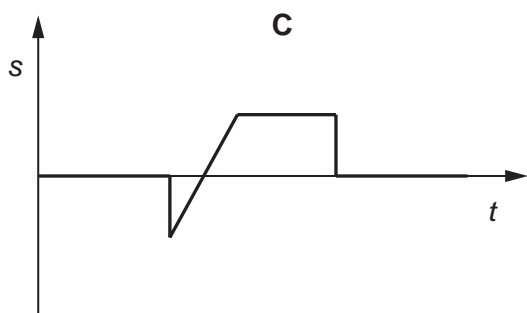
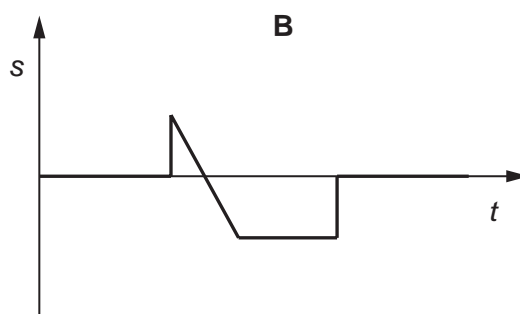
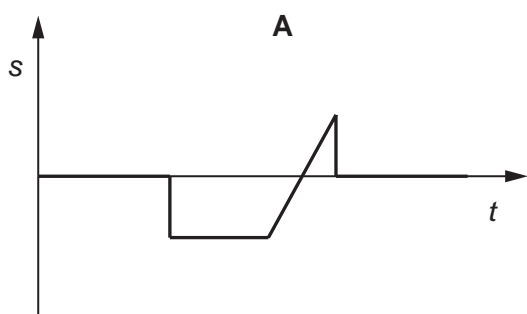

27 The table contains statements about stationary and progressive waves.

Which row is correct?

	stationary wave	progressive wave
A	all particles vibrate with the same amplitude	all particles vibrate with the same amplitude
B	energy is transferred along the wave	energy is transferred along the wave
C	particles in adjacent loops vibrate in antiphase	particles vibrate in phase with their immediate neighbours
D	particles one wavelength apart vibrate in phase	particles one wavelength apart vibrate in phase

28 Which electromagnetic wave would cause the most significant diffraction effect for an atomic lattice of spacing around 10^{-10} m?

- A** infra-red
- B** microwave
- C** ultraviolet
- D** X-ray

29 Wave generators at points X and Y produce water waves of the same wavelength. At point Z, the waves from X have the same amplitude as the waves from Y. Distances XZ and YZ are as shown.

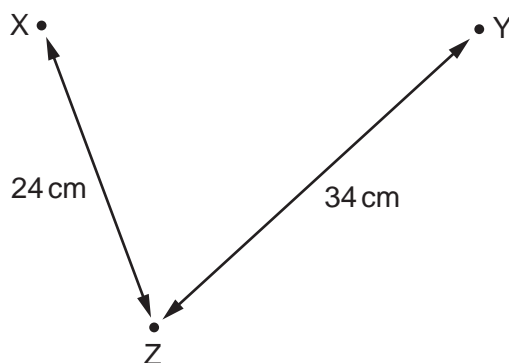

When the wave generators operate in phase, the amplitude of oscillation at Z is zero.

What could be the wavelength of the waves?

- A** 2 cm
- B** 3 cm
- C** 4 cm
- D** 6 cm

- 30 A molecule behaves as an electric dipole consisting of two equal point charges, of opposite sign, separated by a fixed distance. The molecule moves with constant horizontal velocity as it enters a vertical uniform electric field, as shown.

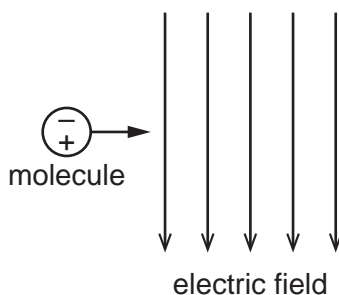

The positive and negative charges of the molecule enter the field at the same time.

Which row describes the velocity of the molecule in the field?

	horizontal component of velocity	vertical component of velocity
A	constant	increases
B	constant	zero
C	increases	increases
D	increases	zero

- 31 Which diagram best represents the electric field between two point charges of equal magnitude and opposite sign?

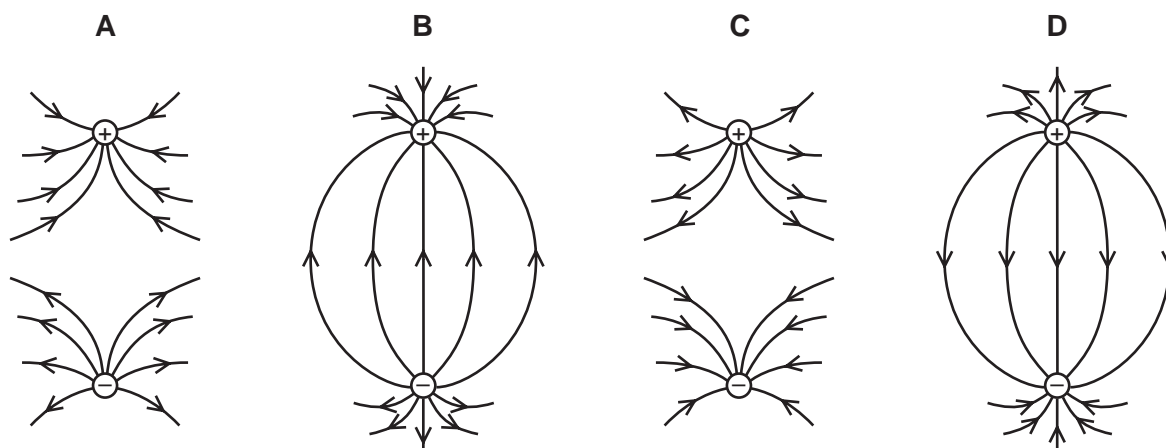

- 32 A pedal bicycle is fitted with an electric motor. The rider switches on the motor for a time of 3.0 minutes. A constant current of 3.5 A in the electric motor is provided from a battery with a terminal voltage of 24 V.

What is the energy supplied by the battery?

- A** 84 J **B** 250 J **C** 630 J **D** 15 000 J

33 The diagram shows a simple circuit.

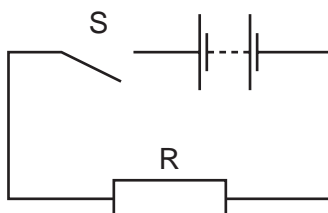

Which statement is correct?

- A When switch S is closed, the electromotive force (e.m.f.) of the battery falls because work is done against the internal resistance of the battery.
 - B When switch S is closed, the e.m.f. of the battery falls because work is done against the resistance of R.
 - C When switch S is closed, the potential difference across the battery falls because work is done against the internal resistance of the battery.
 - D When switch S is closed, the potential difference across the battery falls because work is done against the resistance of R.
- 34 A simple circuit is formed by connecting a resistor of resistance R between the terminals of a battery of electromotive force (e.m.f.) 9.0V and constant internal resistance r .

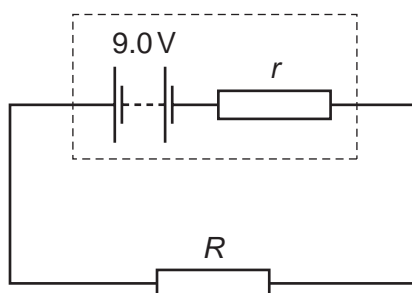

A charge of 6.0C flows through the resistor in a time of 2.0 minutes causing it to dissipate 48J of thermal energy.

What is the internal resistance r of the battery?

- A $0.17\ \Omega$
 - B $0.33\ \Omega$
 - C $20\ \Omega$
 - D $160\ \Omega$
- 35 A source of e.m.f. 9.0mV has an internal resistance of $6.0\ \Omega$.

It is connected across a galvanometer of resistance $30\ \Omega$.

What is the current in the galvanometer?

- A $250\ \mu\text{A}$
- B $300\ \mu\text{A}$
- C $1.5\ \text{mA}$
- D $2.5\ \text{mA}$

36 A box with four terminals P, Q, R and S contains two identical resistors.

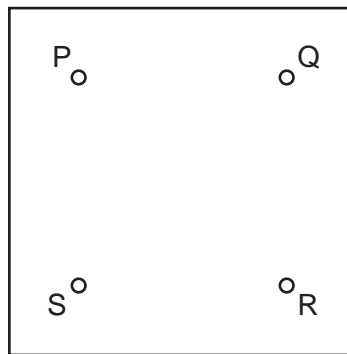

When a battery of electromotive force (e.m.f.) E and negligible internal resistance is connected across PS, a high-resistance voltmeter connected across QR reads $\frac{E}{2}$.

Which diagram shows the correct arrangement of the two resistors inside the box?

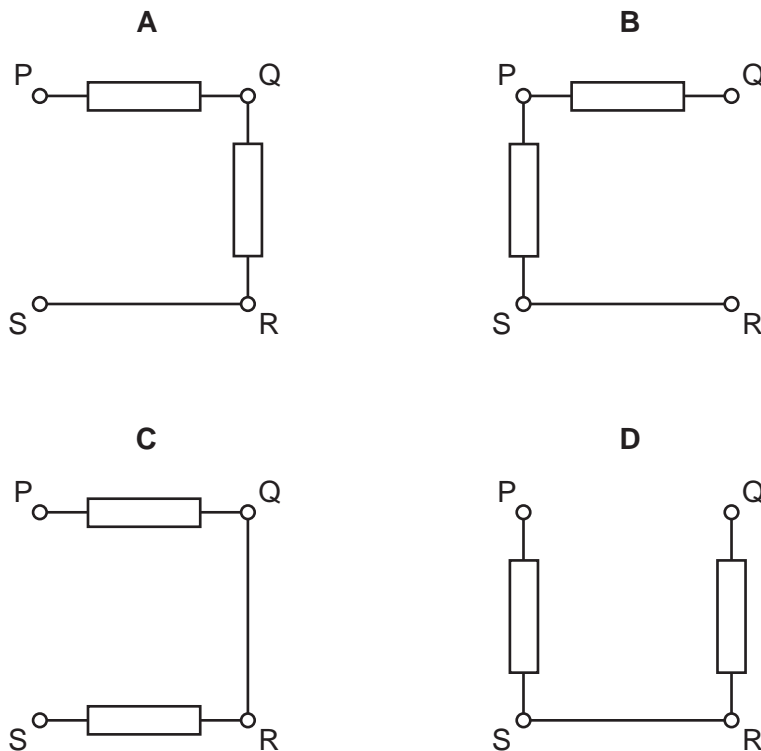

- 37 The diagram shows part of a current-carrying circuit. The ammeter has negligible resistance.

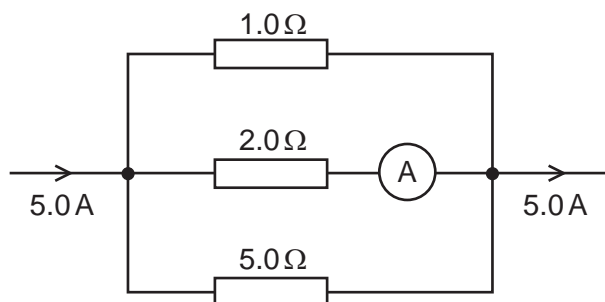

What is the reading on the ammeter?

- A 0.7 A B 1.3 A C 1.5 A D 1.7 A
- 38 Nucleus P decays in two stages to produce nucleus Q.
- Which decay sequence will result in the highest number of neutrons in nucleus Q?
- A an α -particle followed by a β -particle
 B an α -particle followed by a γ -ray
 C a β -particle followed by another β -particle
 D a β -particle followed by a γ -ray
- 39 A neutral atom has a nucleus given by the symbol ${}_{55}^{133}\text{Cs}$.
- How many protons, neutrons and electrons are in this atom?

	protons	neutrons	electrons
A	55	78	55
B	55	133	55
C	78	55	78
D	133	55	133

40 The nuclear equation for a fission reaction is shown below.

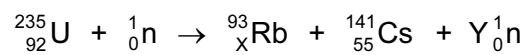

What are the values of X and Y?

	X	Y
A	37	0
B	37	1
C	37	2
D	38	2

BLANK PAGE

Permission to reproduce items where third-party owned material protected by copyright is included has been sought and cleared where possible. Every reasonable effort has been made by the publisher (UCLES) to trace copyright holders, but if any items requiring clearance have unwittingly been included, the publisher will be pleased to make amends at the earliest possible opportunity.

To avoid the issue of disclosure of answer-related information to candidates, all copyright acknowledgements are reproduced online in the Cambridge International Examinations Copyright Acknowledgements Booklet. This is produced for each series of examinations and is freely available to download at www.cie.org.uk after the live examination series.

Cambridge International Examinations is part of the Cambridge Assessment Group. Cambridge Assessment is the brand name of University of Cambridge Local Examinations Syndicate (UCLES), which is itself a department of the University of Cambridge.